

对本手册所包含的内容,浙江飞龙电气有限公司拥有最终解释权,更多详细资料敬请垂询;
本公司工程技术人员将竭诚为您服务,因产品技术不断创新,请以实物或说明书为准;
如有变更,届时恕不另行通知。

NANTE®



产品选型手册

Product selection manual

工业接插装置供应商
Industrial plug device supplier

www.nante.com



NANTE®

飞龙电气有限公司
FLY-DRAGON ELECTRIC CO.,LTD.

中国·浙江省温州市柳市镇车站路688号
No.688, chezhan road, liushi, wenzhou, zhejiang, CHINA

电话/Tel: +86-0577-62731897
传真/Fax: +86-577-62731887, 62731886

<http://www.nante.com/>
E-mail: shireen@nante.com

飞龙电气有限公司
FLY-DRAGON ELECTRIC CO.,LTD.



企业简介

FLY-DRAGON ELECTRIC

飞龙电气是集科研、开发、制造、销售、服务为一体的高低电压电气专业企业。创建于1985年，历经三十年的艰苦努力。秉承科技创新理念，并同多所科研院校合作，不断提升产品科技含量，本着以人为本，以和为贵，共同发展，达到共赢的企业核心价值观，形成了企业差异化、多元化、规模化、集团化的发展模式。

公司主导产品：高低压输电成套设备、高压元器件、真空开关、负荷开关、隔离开关、避雷器、跌落式熔断器和工业插头插座、联锁插座、插座箱、断路器、漏电断路器、交流接触器、水泵压力开关、接线端子等。

公司持续有效地执行ISO9001国际质量体系认证，使产品分别获得欧共体CE、CB、俄罗斯PCT、瑞典S、阿根廷IRAM等国际认证和中国CCC质量认证。同时历年来公司一直被评为市先进企业、明星企业、出口创汇先进企业、外商投资先进企业、全国诚信AAA级企业、银行资信AAA企业等荣誉称号。

公司产品已远销欧洲、南北美洲、中东、澳洲、亚洲等100多个国家和地区，并已形成良好的营销网络。现代企业的营销理念和人文情怀使公司产品在国内外市场上赢得良好的口碑。

Fly-dragon Electric Co.,Ltd, established in 1985, is known as a leading manufacturer of high and low-voltage electric appliance, which has integrated scientific research, development, produce, sales and service. We uphold the concept of technological innovation and cooperate with colleges and institutions to enhance the technology content of products constantly. Based on the principles of people oriented, peace being most precious, common development and core value of win-win, we formed a development mode of differentiation, diversification, largescale and collectivization.

Our leading products include high and low voltage transmission and distribution equipment, high voltage components, vacuum switch, load switch, disconnector, arrester, drop-fuset as well as industrial plug and socket interlocked socket, socket box, circuit breaker, residual current circuit breaker, AC contactor, pump pressure switch, terminal and so on.

We implement ISO9001 strictly and effectively, and most of our products have got the world famous certificates such as CE, CB, Russian PCT, Sweden S, Argentina IRAM and China CCC. We also have obtained the prizes of Advanced Enterprise, the City Star Enterprise, the Advanced Export Enterprises, Advanced Foreign Invested Enterprise, AAA National Credit Enterprise, AAA Bank Credit Enterprises, etc.

Having our products exported to more than 100 countries and regions such as Europe, North and South America, Middle east, Australia, Asia we have developed a good marketing network. Modern enterprise marketing concepts and humanity won our company a good reputation in both domestic and overseas markets

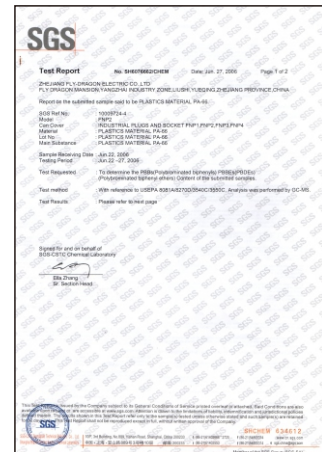

main parameters of IEC 60309 for Industrial plug & socket

voltage V	Frequency Hz	2P+E		2P+E		2P+E	
		16+32A	63+125A	16+32A	16+125A	16+32A	16+125A
63,5/110 to 75/130	50+60					4	4
110to130	50+60	4	4	4	4		
120/280 to 144/130	50+60					9	9
220 to 250	50+60	6	6	9	9		
220/380 to 240/130	50+60					6	6
220/380 to 250/440	50+60					3	3
250/400 to 265/460	60					11	11
277	60	5	5				
277/480 to 280/130	50+60					7	7
347/600 to 400/690	50+60					5	5
380 to 415	50+60	9	9	6	6		
380;440	50+60			3	3		
440 to 460	60			11	11		
480 to 500	50+60	7	7	7	7		
600 to 690	50+60			5	5		
under 50	100 to 300	10	10	10	10	10	10
under 50	>300 to 500	2	2	2	2	2	2
above 50 to 250		3	3				
under 250		8	8				
single phase	50+60	12	12	12	12		

IEC 60309 plugs and socket-outlets for industrial use standards

Fn 系列工业插头和插座符合以下国际标准:IEC60309-1和IEC60309-2,CEIEN 60309-1和CEIEN60309-2,也符合VDE 0623和BS4343。

FN series industrial plugs and socket-outlets are in compliance with the following international standards:IEC60309-1 & IEC60309-2,CEIEN60309-1 & CEIEN 60309-2

They are also in compliance with the standards:VDE0623,BS4343.

优点 Advantage

该产品具有很好的绝缘性能,具有防水、防尘、防溅、防腐抗老化等特点,并有先进的设计,因而适用于IP44和IP67等级所需要的环境中。

Voltage	Color
20-25V	violet
40-50V	white
100-130V	yellow
200-250V	blue
380-480V	red
500-690V	black
>60-500Hz	green

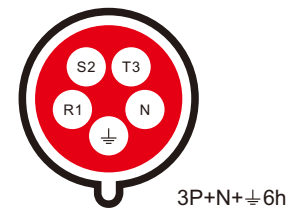
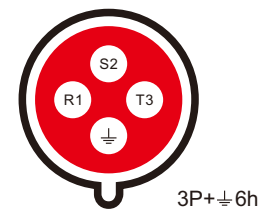
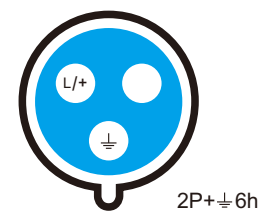
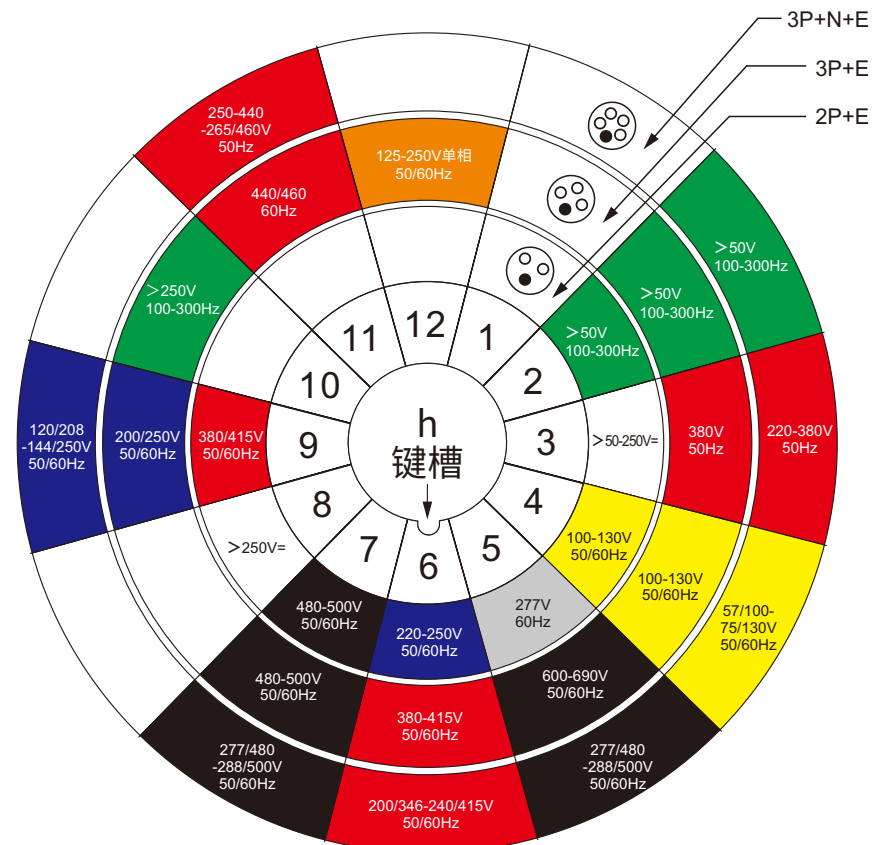

CONTENTS

手册目录 MaNUAL cATALOGUE

经济型插头插座
Economical plug socket



螺旋型插头插座
Screw plug socket



高端型插头插座
High-end plug socket



欧式插头插座
European plug socket



连锁插座盒
Chain socket box



多头输出插座
Multihead output socket



工业插座箱
Industrial socket box



电缆防水接头
Cable waterproof joint



防水窗口
Waterproof window



电流 16A/32A 防水等级 IP44
FNP1代 经济型工业插头



FNP1-013-4
FNP1-023-4

电流 Current(A):16A 32A
电压 Voltage(V):110-130V~
防护等级 Protection degree:IP44

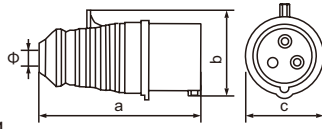

Earth contact position		4h	
Normal current(A)		16A	32A
No.poles		2P+E	
Dimension(mm)	a	122	139
	b	59	75
	c	51	64
	Φ	6	8
Cable nominal cross-section area(mm ²)		1-2.5	2.5-6



FNP1-013
FNP1-023

电流 Current(A):16A 32A
电压 Voltage(V):200-250V~
防护等级 Protection degree:IP44

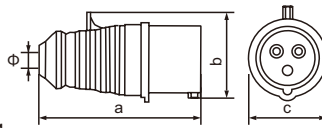

Earth contact position		6h	
Normal current(A)		16A	32A
No.poles		2P+E	
Dimension(mm)	a	122	139
	b	59	75
	c	51	64
	Φ	6	8
Cable nominal cross-section area(mm ²)		1-2.5	2.5-6



FNP1-014
FNP1-024

电流 Current(A):16A 32A
电压 Voltage(V):380-415V~
防护等级 Protection degree:IP44

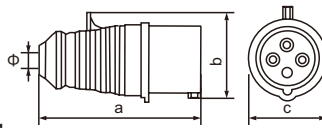

Earth contact position		6h	
Normal current(A)		16A	32A
No.poles		3P+E	
Dimension(mm)	a	122	139
	b	65	75
	c	51	64
	Φ	6	8
Cable nominal cross-section area(mm ²)		1-2.5	2.5-6



FNP1-015
FNP1-025

电流 Current(A):16A 32A
电压 Voltage(V):200-346V~
240-415V~
防护等级 Protection degree:IP44

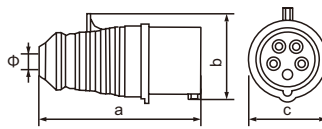

Earth contact position		6h	
Normal current(A)		16A	32A
No.poles		3P+N+E	
Dimension(mm)	a	130	143
	b	72	84
	c	64	70
	Φ	8	8
Cable nominal cross-section area(mm ²)		1-2.5	2.5-6



FNP1-013L
FNP1-023L

电流 Current(A):16A 32A
电压 Voltage(V):200-250V~
防护等级 Protection degree:IP44

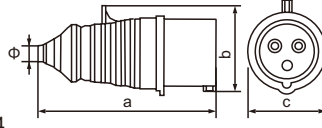

Earth contact position		6h	
Normal current(A)		16A	32A
No.poles		2P+E	
Dimension(mm)	a	141	172
	b	59	75
	c	51	64
	Φ	7-16	7-20
Cable nominal cross-section area(mm ²)		1-2.5	2.5-6



FNP1-014L
FNP1-024L

电流 Current(A):16A 32A
电压 Voltage(V):380-415V~
防护等级 Protection degree:IP44

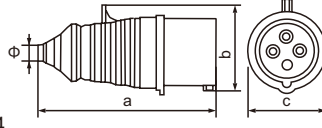

Earth contact position		6h	
Normal current(A)		16A	32A
No.poles		3P+E	
Dimension(mm)	a	141	172
	b	65	75
	c	51	64
	Φ	7-16	7-20
Cable nominal cross-section area(mm ²)		1-2.5	2.5-6

Earth contact position		6h	
Normal current(A)		16A	32A
No.poles		3P+N+E	
Dimension(mm)	a	161	174
	b	75	87
	c	64	70
	Φ	7-20	7-20
Cable nominal cross-section area(mm ²)		1-2.5	2.5-6

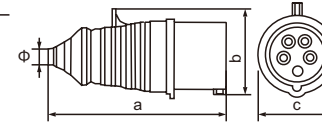

FNP1-015L
FNP1-025L

电流 Current(A):16A 32A
电压 Voltage(V):200-346V~
240-415V~
防护等级 Protection degree:IP44



Earth contact position		9h	
Normal current(A)		16A	32A
No.poles		2P+E	
Dimension(mm)	a	141	172
	b	59	75
	c	51	64
	Φ	7-16	7-20
Cable nominal cross-section area(mm ²)		1-2.5	2.5-6

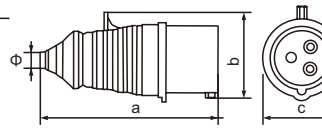

FNP1-013L-9
FNP1-023L-9

电流 Current(A):16A 32A
电压 Voltage(V):380-415V~
防护等级 Protection degree:IP44



Earth contact position		9h	
Normal current(A)		16A	32A
No.poles		3P+E	
Dimension(mm)	a	141	172
	b	65	75
	c	51	64
	Φ	7-16	7-20
Cable nominal cross-section area(mm ²)		1-2.5	2.5-6

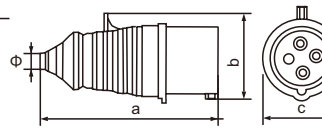

FNP1-014L-9
FNP1-024L-9

电流 Current(A):16A 32A
电压 Voltage(V):220-240V~
防护等级 Protection degree:IP44



Earth contact position		9h	
Normal current(A)		16A	32A
No.poles		3P+N+E	
Dimension(mm)	a	161	174
	b	75	87
	c	64	70
	Φ	7-20	7-20
Cable nominal cross-section area(mm ²)		1-2.5	2.5-6

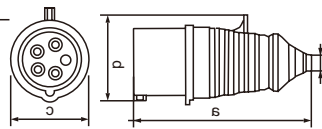

FNP1-015L-9
FNP1-025L-9

电流 Current(A):16A 32A
电压 Voltage(V):220-240V~
防护等级 Protection degree:IP44

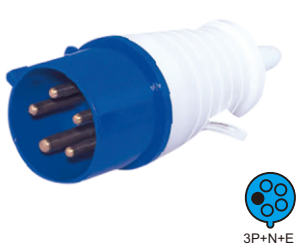

Earth contact position		6h	
Normal current(A)		63A	125A
No.poles		2P+E	
Dimension(mm)	a	231.5	293
	b	110	125
	c	16-38	30-64
	Φ	110	125
Cable nominal cross-section area(mm ²)		6-16	16-50

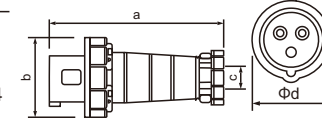

FNP1-033
FNP1-043

电流 Current(A):63A 125A
电压 Voltage(V):200-250V~
防护等级 Protection degree:IP67



Earth contact position		6h	
Normal current(A)		63A	125A
No.poles		3P+E	
Dimension(mm)	a	231.5	293
	b	110	125
	c	16-38	30-64
	Φ	110	125
Cable nominal cross-section area(mm ²)		6-16	16-50

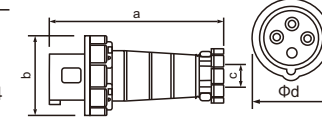

FNP1-034
FNP1-044

电流 Current(A):63A 125A
电压 Voltage(V):380-415V~
防护等级 Protection degree:IP67



电流 63A/125A 防水等级 IP67
FNP1代 经济型工业插头



FNP1-035
FNP1-045

电流 Current(A):63A 125A
电压 Voltage(V):200-346V~
240-415V~

防护等级 Protection degree:IP67

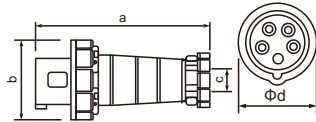

Earth contact position	6h	
Normal current(A)	63A	125A
No.poles	3P+N+E	
Dimension(mm)	a	231.5 293
	b	110 125
	c	16-38 30-64
	Φ	110 125
	Cable nominal cross-section area(mm ²)	6-16

电流 16A/32A 防水等级 IP44
FNP2代 螺旋快速安装型工业插头

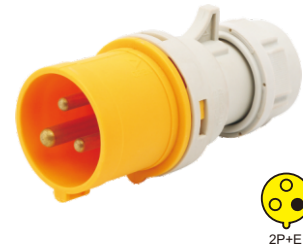

FNP2-013-4
FNP2-023-4

电流 Current(A):16A 32A
电压 Voltage(V):110-130V~
防护等级 Protection degree:IP44

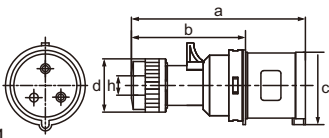

Earth contact position	4h	
Normal current(A)	16A	32A
No.poles	2P+E	
Dimension(mm)	a	127 158
	b	87 105
	c	46.5 63
	d	42.5 55.5
Cable nominal cross-section area(mm ²)	1-2.5	2.5-6



FNP2-013
FNP2-023

电流 Current(A):16A 32A
电压 Voltage(V):200-250V~
防护等级 Protection degree:IP44

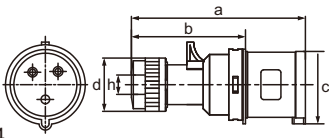

Earth contact position	6h	
Normal current(A)	16A	32A
No.poles	2P+E	
Dimension(mm)	a	118 138
	b	82 95.5
	c	46.5 63
	d	42.5 55.5
Cable nominal cross-section area(mm ²)	1-2.5	2.5-6



FNP2-014
FNP2-024

电流 Current(A):16A 32A
电压 Voltage(V):380-415V~
防护等级 Protection degree:IP44

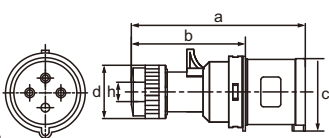

Earth contact position	6h	
Normal current(A)	16A	32A
No.poles	3P+E	
Dimension(mm)	a	124 138
	b	88.5 95.5
	c	53.5 63
	d	42.5 55.5
Cable nominal cross-section area(mm ²)	1-2.5	2.5-6



FNP2-015
FNP2-025

电流 Current(A):16A 32A
电压 Voltage(V):200-346V~
240-415V~

防护等级 Protection degree:IP44

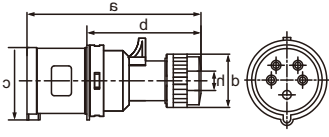

Earth contact position	6h	
Normal current(A)	16A	32A
No.poles	3P+N+E	
Dimension(mm)	a	128 142
	b	94 100
	c	60.5 69.5
	d	45.5 55.5
Cable nominal cross-section area(mm ²)	1-2.5	2.5-6

电流 16A/32A 防水等级 IP67
FNP2代 螺旋快速安装型工业插头

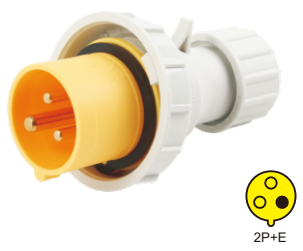

FNP2-013F-4
FNP2-023F-4

电流 Current(A):16A 32A
电压 Voltage(V):110-130V~
防护等级 Protection degree:IP67

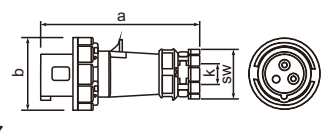

Earth contact position	4h	
Normal current(A)	16A	32A
No.poles	2P+E	
Dimension(mm)	a	127 158
	b	71 93
	k	6-15 10-20
	sw	44 54
Cable nominal cross-section area(mm ²)	1-2.5	2.5-6

Earth contact position	6h	
Normal current(A)	16A	32A
No.poles	2P+E	
Dimension(mm)	a	127 158
	b	71 93
	k	6-15 10-20
	sw	44 54
Cable nominal cross-section area(mm ²)	1-2.5	2.5-6

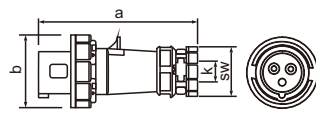

FNP2-013F
FNP2-023F

电流 Current(A):16A 32A
电压 Voltage(V):200-250V~
防护等级 Protection degree:IP67

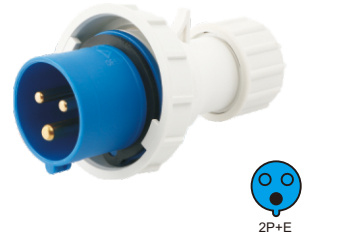

Earth contact position	6h	
Normal current(A)	16A	32A
No.poles	3P+E	
Dimension(mm)	a	133 158
	b	79 93
	k	6-15 10-20
	sw	44 54
Cable nominal cross-section area(mm ²)	1-2.5	2.5-6

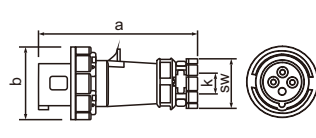

FNP2-014F
FNP2-024F

电流 Current(A):16A 32A
电压 Voltage(V):380-415V~
防护等级 Protection degree:IP67



Earth contact position	6h	
Normal current(A)	16A	32A
No.poles	3P+N+E	
Dimension(mm)	a	140 165
	b	87 100
	k	6-15 10-20
	sw	44 54
Cable nominal cross-section area(mm ²)	1-2.5	2.5-6

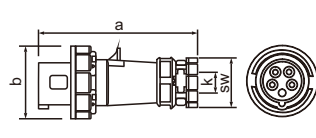

FNP2-015F
FNP2-025F

电流 Current(A):16A 32A
电压 Voltage(V):200-346V~
240-415V~

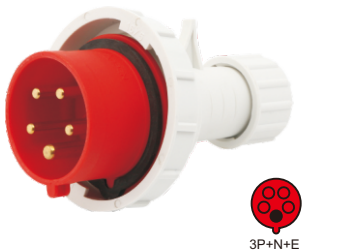

Earth contact position	6h	
Normal current(A)	63A	125A
No.poles	2P+E	
Dimension(mm)	a	250 275
	b	115 128
	k	23 31
	sw	63 79
Cable nominal cross-section area(mm ²)	6-16	16-50

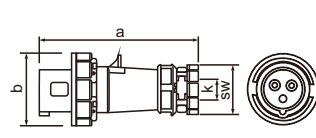

FNP2-033F
FNP2-043F

电流 Current(A):63A 125A
电压 Voltage(V):200-250V~
防护等级 Protection degree:IP67

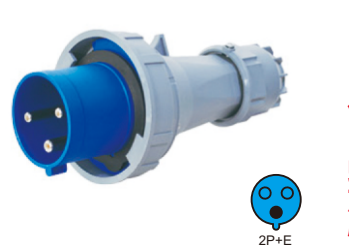

Earth contact position	6h	
Normal current(A)	63A	125A
No.poles	3P+E	
Dimension(mm)	a	250 275
	b	115 128
	k	23 31
	sw	63 79
Cable nominal cross-section area(mm ²)	6-16	16-50

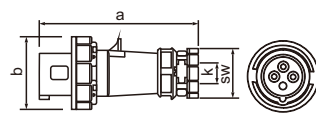

FNP2-034F
FNP2-044F

电流 Current(A):63A 125A
电压 Voltage(V):380-415V~
防护等级 Protection degree:IP67

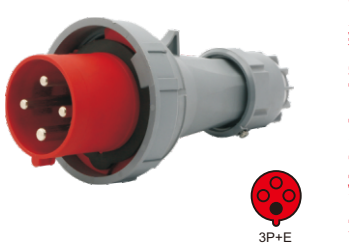

Earth contact position	6h	
Normal current(A)	63A	125A
No.poles	3P+N+E	
Dimension(mm)	a	250 275
	b	115 128
	k	23 31
	sw	63 79
Cable nominal cross-section area(mm ²)	6-16	16-50

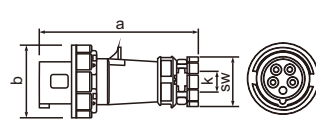

FNP2-035F
FNP2-045F

电流 Current(A):63A 125A
电压 Voltage(V):200-346V~
240-415V~

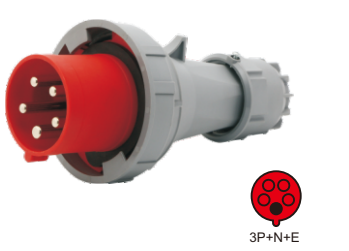

电流 16A/32A 防水等级 IP44
FNP3 3代 高端型工业插头



FNP3-013-4
FNP3-023-4
电流 Current(A):16A 32A
电压 Voltage(V):110-130V~
防护等级 Protection degree:IP44

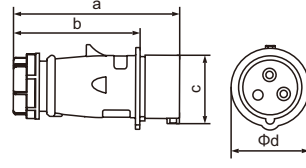

Earth contact position	4h	
Normal current(A)	16A	32A
No.poles	2P+E	
Dimension(mm)	a	142 175
	b	108 134
	c	47 63
	d	63 86
Cable nominal cross-section area(mm ²)	1-2.5	2.5-6

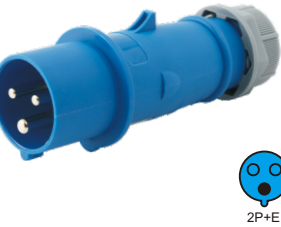

FNP3-013
FNP3-023
电流 Current(A):16A 32A
电压 Voltage(V):200-250V~
防护等级 Protection degree:IP44

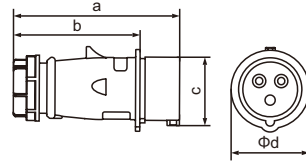

Earth contact position	6h	
Normal current(A)	16A	32A
No.poles	2P+E	
Dimension(mm)	a	142 175
	b	108 134
	c	47 63
	d	63 86
Cable nominal cross-section area(mm ²)	1-2.5	2.5-6



FNP3-014
FNP3-024
电流 Current(A):16A 32A
电压 Voltage(V):380-415V~
防护等级 Protection degree:IP44

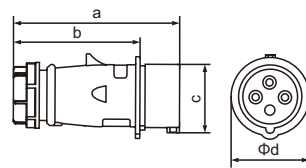

Earth contact position	6h	
Normal current(A)	16A	32A
No.poles	3P+E	
Dimension(mm)	a	145 175
	b	113 134
	c	54 63
	d	68 86
Cable nominal cross-section area(mm ²)	1-2.5	2.5-6



FNP3-015
FNP3-025
电流 Current(A):16A 32A
电压 Voltage(V):200-346V~
240-415V~
防护等级 Protection degree:IP44

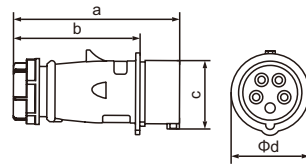

Earth contact position	6h	
Normal current(A)	16A	32A
No.poles	3P+N+E	
Dimension(mm)	a	147 175
	b	115 134
	c	61 69
	d	76 89
Cable nominal cross-section area(mm ²)	1-2.5	2.5-6



FNP3-013F-4
FNP3-023F-4
电流 Current(A):16A 32A
电压 Voltage(V):110-130V~
防护等级 Protection degree:IP67

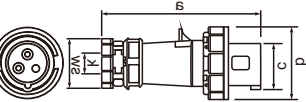

Earth contact position	4h	
Normal current(A)	16A	32A
No.poles	2P+E	
Dimension(mm)	a	142 175
	b	76 99
	c	47 63
Cable nominal cross-section area(mm ²)	1-2.5	2.5-6



FNP3-013F
FNP3-023F
电流 Current(A):16A 32A
电压 Voltage(V):200-250V~
防护等级 Protection degree:IP67

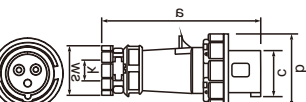

Earth contact position	6h	
Normal current(A)	16A	32A
No.poles	2P+E	
Dimension(mm)	a	142 175
	b	76 99
	c	47 63
Cable nominal cross-section area(mm ²)	1-2.5	2.5-6

Earth contact position	6h	
Normal current(A)	16A	32A
No.poles	3P+E	
Dimension(mm)	a	145 175
	b	83 99
	c	54 63
Cable nominal cross-section area(mm ²)	1-2.5	2.5-6

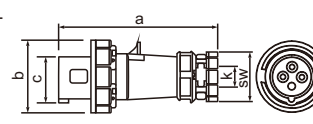

FNP3-014F
FNP3-024F
电流 Current(A):16A 32A
电压 Voltage(V):380-415V~
防护等级 Protection degree:IP67

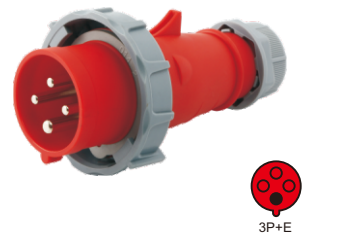

Earth contact position	6h	
Normal current(A)	16A	32A
No.poles	3P+N+E	
Dimension(mm)	a	147 175
	b	93 107
	c	61 69
Cable nominal cross-section area(mm ²)	1-2.5	2.5-6

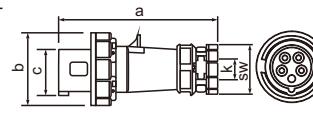

FNP3-015F
FNP3-025F
电流 Current(A):16A 32A
电压 Voltage(V):200-346V~
240-415V~
防护等级 Protection degree:IP67

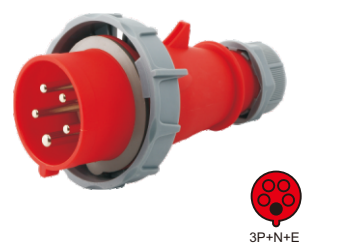

Earth contact position	4h	
Normal current(A)	16A	32A
No.poles	2P+E	
Dimension(mm)	a	135 153
	b	92 102
	c	50 65
	Φ	3-18 3-18
Cable nominal cross-section area(mm ²)	1-2.5	2.5-6

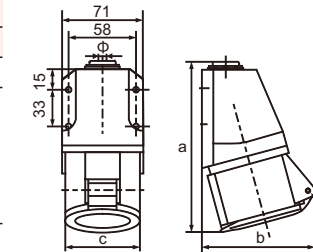

FNP1-113-4
FNP1-123-4
电流 Current(A):16A 32A
电压 Voltage(V):110-130V~
防护等级 Protection degree:IP44

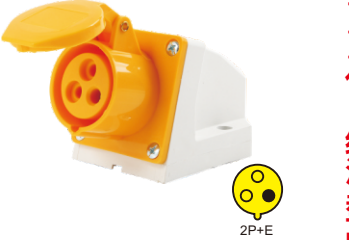

Earth contact position	6h	
Normal current(A)	16A	32A
No.poles	2P+E	
Dimension(mm)	a	135 153
	b	92 102
	c	50 65
	Φ	3-18 3-18
Cable nominal cross-section area(mm ²)	1-2.5	2.5-6

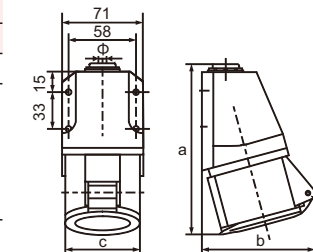

FNP1-113
FNP1-123
电流 Current(A):16A 32A
电压 Voltage(V):200-250V~
防护等级 Protection degree:IP44



Earth contact position	6h	
Normal current(A)	16A	32A
No.poles	3P+E	
Dimension(mm)	a	140 152
	b	95 104
	c	56 65
	Φ	3-18 3-18
Cable nominal cross-section area(mm ²)	1-2.5	2.5-6

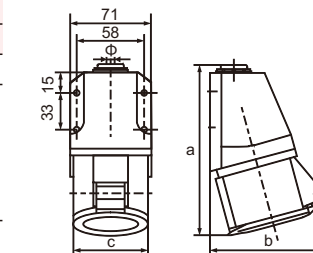

FNP1-114
FNP1-124
电流 Current(A):16A 32A
电压 Voltage(V):380-415V~
防护等级 Protection degree:IP44



Earth contact position	6h	
Normal current(A)	16A	32A
No.poles	3P+N+E	
Dimension(mm)	a	139 153
	b	96 107
	c	63 70
	Φ	3-18 3-18
Cable nominal cross-section area(mm ²)	1-2.5	2.5-6

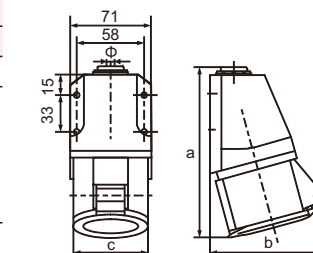

FNP1-115
FNP1-125
电流 Current(A):16A 32A
电压 Voltage(V):200-346V~
240-415V~
防护等级 Protection degree:IP44



电流 16A/32A 防水等级 IP67
FNP3 3代 高端型工业插头

电流 16A/32A 防水等级 IP44
FNP1 1代 经济型明装插座



FNP1-113L-9
FNP1-123L-9
电流 Current(A):16A 32A
电压 Voltage(V):380-415V~
防护等级 Protection degree:IP44

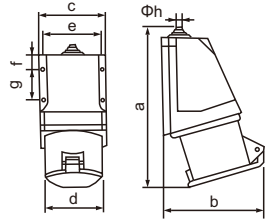

Earth contact position	9h	
Normal current(A)	16A	32A
No.poles	2P+E	
Dimension(mm)	a	135
	b	92
	c	71
	d	51
	e	56
	f	15
	g	33.5
	h	3-18
Cable nominal cross-section area(mm ²)	1-2.5	2.5-6



FNP1-114L-9
FNP1-124L-9
电流 Current(A):16A 32A
电压 Voltage(V):220-240V~
防护等级 Protection degree:IP44

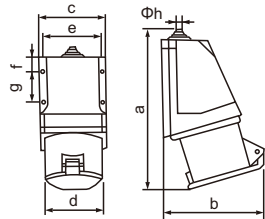

Earth contact position	9h	
Normal current(A)	16A	32A
No.poles	3P+E	
Dimension(mm)	a	140
	b	95
	c	71
	d	56
	e	56
	f	20
	g	33.5
	h	3-18
Cable nominal cross-section area(mm ²)	1-2.5	2.5-6



FNP1-115L-9
FNP1-125L-9
电流 Current(A):16A 32A
电压 Voltage(V):220-240V~
防护等级 Protection degree:IP44

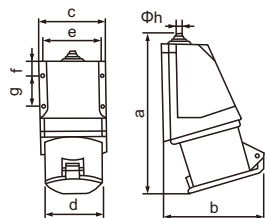

Earth contact position	9h	
Normal current(A)	16A	32A
No.poles	3P+N+E	
Dimension(mm)	a	140
	b	96
	c	71
	d	63
	e	56
	f	20
	g	33.5
	h	3-18
Cable nominal cross-section area(mm ²)	1-2.5	2.5-6



FNP1-113L
FNP1-123L
电流 Current(A):16A 32A
电压 Voltage(V):200-250V~
防护等级 Protection degree:IP44

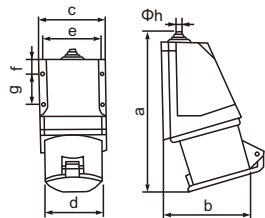

Earth contact position	6h	
Normal current(A)	16A	32A
No.poles	2P+E	
Dimension(mm)	a	168
	b	92
	c	71
	d	51
	e	56
	f	15
	g	33.5
	h	7-20
Cable nominal cross-section area(mm ²)	1-2.5	2.5-6



FNP1-114L
FNP1-124L
电流 Current(A):16A 32A
电压 Voltage(V):380-415V~
防护等级 Protection degree:IP44

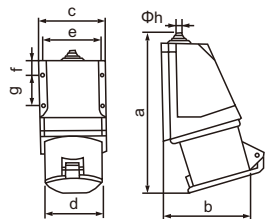

Earth contact position	6h	
Normal current(A)	16A	32A
No.poles	3P+E	
Dimension(mm)	a	170
	b	95
	c	71
	d	56
	e	56
	f	15
	g	33.5
	h	7-20
Cable nominal cross-section area(mm ²)	1-2.5	2.5-6



FNP1-115L
FNP1-125L
电流 Current(A):16A 32A
电压 Voltage(V):200-346V~
240-415V~
防护等级 Protection degree:IP44

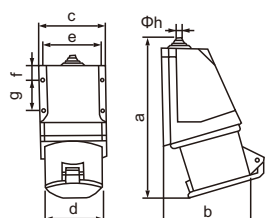

Earth contact position	6h	
Normal current(A)	16A	32A
No.poles	3P+N+E	
Dimension(mm)	a	166
	b	100
	c	71
	d	63
	e	56
	f	15
	g	33.5
	h	7-20
Cable nominal cross-section area(mm ²)	1-2.5	2.5-6



Earth contact position	6h	
Normal current(A)	63A	125A
No.poles	2P+E	
Dimension(mm)	a	134
	b	311
	c	108
	d	111
	e	20
	f	158
	g	6
	h	6.2
Cable nominal cross-section area(mm ²)	6-16	16-50

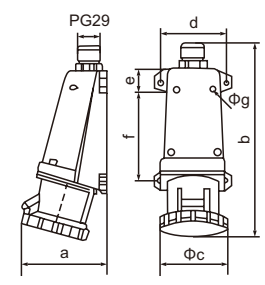

FNP1-133
FNP1-143
电流 Current(A):63A 125A
电压 Voltage(V):200-250V~
防护等级 Protection degree:IP67



Earth contact position	6h	
Normal current(A)	63A	125A
No.poles	3P+E	
Dimension(mm)	a	134
	b	311
	c	108
	d	111
	e	20
	f	158
	g	6
	h	6.2
Cable nominal cross-section area(mm ²)	6-16	16-50

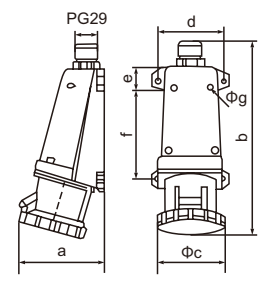

FNP1-134
FNP1-144
电流 Current(A):63A 125A
电压 Voltage(V):380-415V~
防护等级 Protection degree:IP67



Earth contact position	6h	
Normal current(A)	63A	125A
No.poles	3P+E	
Dimension(mm)	a	134
	b	311
	c	108
	d	111
	e	20
	f	158
	g	6
	h	6.2
Cable nominal cross-section area(mm ²)	6-16	16-50

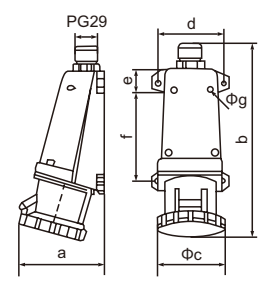

FNP1-135
FNP1-145
电流 Current(A):63A 125A
电压 Voltage(V):200-346V~
240-415V~
防护等级 Protection degree:IP67



Earth contact position	4h	
Normal current(A)	16A	32A
No.poles	2P+E	
Dimension(mm)	a	136
	b	70.5
	c	86
	d	58
	e	33
	f	5.0
Cable nominal cross-section area(mm ²)	1-2.5	2.5-6

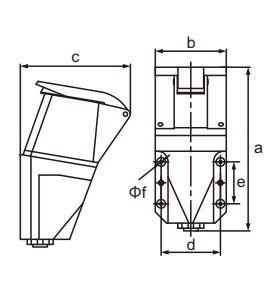

FNP2-113-4
FNP2-123-4
电流 Current(A):16A 32A
电压 Voltage(V):110-130V~
防护等级 Protection degree:IP44



Earth contact position	6h	
Normal current(A)	16A	32A
No.poles	2P+E	
Dimension(mm)	a	136
	b	70.5
	c	86
	d	58
	e	33
	f	5.0
Cable nominal cross-section area(mm ²)	1-2.5	2.5-6

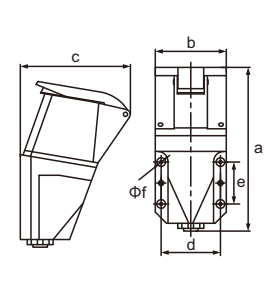

FNP2-113
FNP2-123
电流 Current(A):16A 32A
电压 Voltage(V):200-250V~
防护等级 Protection degree:IP44



Earth contact position	6h	
Normal current(A)	16A	32A
No.poles	3P+E	
Dimension(mm)	a	138
	b	70.5
	c	90
	d	58
	e	33
	f	5.0
Cable nominal cross-section area(mm ²)	1-2.5	2.5-6

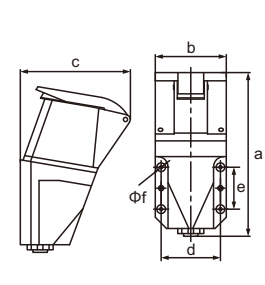

FNP2-114
FNP2-124
电流 Current(A):16A 32A
电压 Voltage(V):380-415V~
防护等级 Protection degree:IP44



电流 63A/125A 防水等级 IP67
FNP1代 经济型明装插座

电流 16A/32A 防水等级 IP44
FNP2代 螺旋快速安装型明装插座



FNP2-115
FNP2-125
电流 Current(A):16A 32A
电压 Voltage(V):200-346V~
240-415V~
防护等级 Protection degree:IP44

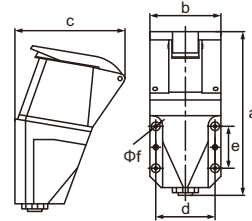

Earth contact position	6h	
Normal current(A)	16A	32A
No.poles	3P+N+E	
Dimension(mm)	a	140 152
	b	70.5 70.5
	c	95 104
	d	58 58
	e	33 33
	f	5.0 5.0
Cable nominal cross-section area(mm ²)	1-2.5	2.5-6

电流 16A/32A 防水等级 IP67
FNP2 2代 螺旋快速安装型明装插座

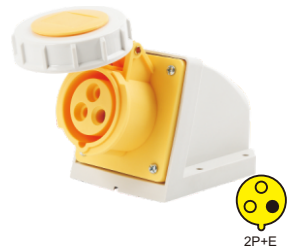

FNP2-113F-4
FNP2-123F-4
电流 Current(A):16A 32A
电压 Voltage(V):110-130V~
防护等级 Protection degree:IP67

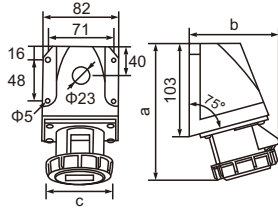

Earth contact position	4h	
Normal current(A)	16A	32A
No.poles	2P+E	
Dimension(mm)	a	145 160
	b	97 110
	c	70 93
Cable nominal cross-section area(mm ²)	1-2.5	2.5-6



FNP2-113F
FNP2-123F
电流 Current(A):16A 32A
电压 Voltage(V):200-250V~
防护等级 Protection degree:IP67

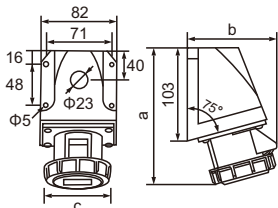

Earth contact position	6h		
Normal current(A)	16A	32A	
No.poles	2P+E		
Dimension(mm)	a	145 160	
	b	97 110	
	c	70 93	
	Cable nominal cross-section area(mm ²)	1-2.5	2.5-6



FNP2-114F
FNP2-124F
电流 Current(A):16A 32A
电压 Voltage(V):380-415V~
防护等级 Protection degree:IP67

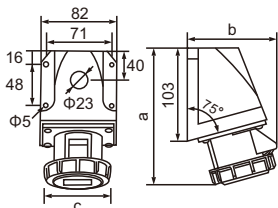

Earth contact position	6h		
Normal current(A)	16A	32A	
No.poles	3P+E		
Dimension(mm)	a	150 160	
	b	100 110	
	c	88 93	
	Cable nominal cross-section area(mm ²)	1-2.5	2.5-6



FNP2-115F
FNP2-125F
电流 Current(A):16A 32A
电压 Voltage(V):200-346V~
240-415V~
防护等级 Protection degree:IP67

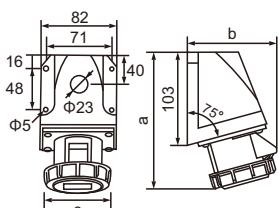

Earth contact position	6h		
Normal current(A)	16A	32A	
No.poles	3P+N+E		
Dimension(mm)	a	150 161	
	b	100 110	
	c	88 100	
	Cable nominal cross-section area(mm ²)	1-2.5	2.5-6

电流 63A/125A 防水等级 IP67
FNP2 2代 螺旋快速安装型



FNP2-133F
FNP2-143F
电流 Current(A):63A 125A
电压 Voltage(V):200-250V~
防护等级 Protection degree:IP67

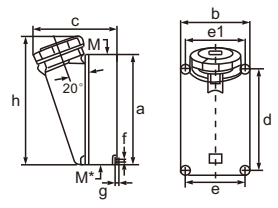

Earth contact position	6h		
Normal current(A)	63A	125A	
No.poles	2P+E		
Dimension(mm)	a	171 260	
	b	119 160	
	c	176 180	
	d	136 241	
	e	103 141	
	h	225 305	
	Cable nominal cross-section area(mm ²)	6-16	16-50

Earth contact position	6h		
Normal current(A)	63A	125A	
No.poles	3P+E		
Dimension(mm)	a	171 260	
	b	119 160	
	c	176 180	
	d	136 241	
	e	103 141	
	h	225 305	
	Cable nominal cross-section area(mm ²)	6-16	16-50

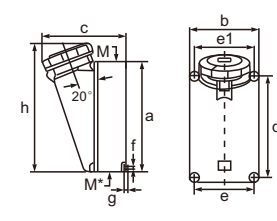

FNP2-134F
FNP2-144F
电流 Current(A):63A 125A
电压 Voltage(V):380-415V~
防护等级 Protection degree:IP67



Earth contact position	6h		
Normal current(A)	63A	125A	
No.poles	3P+N+E		
Dimension(mm)	a	171 260	
	b	119 160	
	c	176 180	
	d	136 241	
	e	103 141	
	h	225 305	
	Cable nominal cross-section area(mm ²)	6-16	16-50

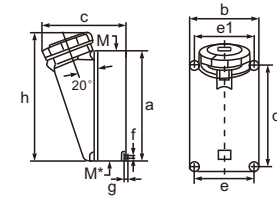

FNP2-135F
FNP2-145F
电流 Current(A):63A 125A
电压 Voltage(V):200-346V~
240-415V~
防护等级 Protection degree:IP67



Earth contact position	4h	
Normal current(A)	16A	32A
No.poles	2P+E	
Dimension(mm)	a	78 80
	b	65 91
	c	95 122
	d	125 160
	e	130 160
	f	88 99
Cable nominal cross-section area(mm ²)	1-2.5	2.5-6

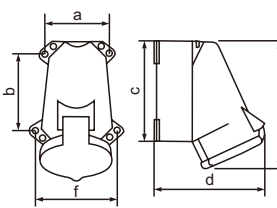

FNP3-113-4
FNP3-123-4
电流 Current(A):16A 32A
电压 Voltage(V):110-130V~
防护等级 Protection degree:IP44



Earth contact position	6h	
Normal current(A)	16A	32A
No.poles	2P+E	
Dimension(mm)	a	78 80
	b	65 91
	c	95 122
	d	125 160
	e	130 160
	f	88 99
Cable nominal cross-section area(mm ²)	1-2.5	2.5-6

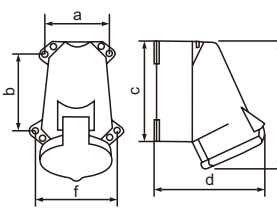

FNP3-113
FNP3-123
电流 Current(A):16A 32A
电压 Voltage(V):200-250V~
防护等级 Protection degree:IP44



Earth contact position	6h	
Normal current(A)	16A	32A
No.poles	3P+E	
Dimension(mm)	a	78 80
	b	65 91
	c	95 122
	d	125 160
	e	130 160
	f	88 99
Cable nominal cross-section area(mm ²)	1-2.5	2.5-6

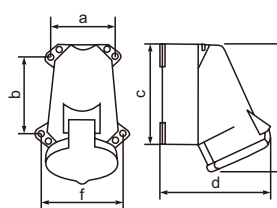

FNP3-114
FNP3-124
电流 Current(A):16A 32A
电压 Voltage(V):380-415V~
防护等级 Protection degree:IP44



Earth contact position	6h		
Normal current(A)	16A	32A	
No.poles	3P+N+E		
Dimension(mm)	a	78 80	
	b	65 91	
	c	95 122	
	d	125 160	
	e	130 160	
	f	88 99	
	Cable nominal cross-section area(mm ²)	1-2.5	2.5-6

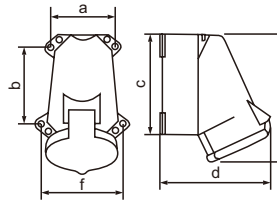

FNP3-115
FNP3-125
电流 Current(A):16A 32A
电压 Voltage(V):200-346V~
240-415V~
防护等级 Protection degree:IP44



电流 16A/32A 防水等级 IP67
FNP3 3代 高端型明装插座



FNP3-113F-4
FNP3-123F-4
电流 Current(A):16A 32A
电压 Voltage(V):110-130V~
防护等级 Protection degree:IP67

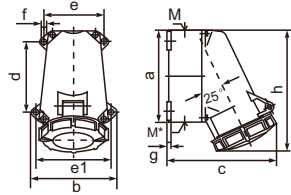

Earth contact position	4h	
Normal current(A)	16A	32A
No.poles	2P+E	
Dimension(mm)	a	95 120
	b	102 112
	c	115 143
	d	64.2 90.2
	e	77.5 79
	e1	88 98.5
Cable nominal cross-section area(mm ²)	1-2.5	2.5-6



FNP3-113F
FNP3-123F
电流 Current(A):16A 32A
电压 Voltage(V):200-250V~
防护等级 Protection degree:IP67

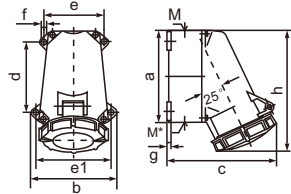

Earth contact position	6h	
Normal current(A)	16A	32A
No.poles	2P+E	
Dimension(mm)	a	95 120
	b	102 112
	c	115 143
	d	64.2 90.2
	e	77.5 79
	e1	88 98.5
Cable nominal cross-section area(mm ²)	1-2.5	2.5-6



FNP3-114F
FNP3-124F
电流 Current(A):16A 32A
电压 Voltage(V):380-415V~
防护等级 Protection degree:IP67

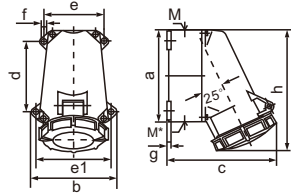

Earth contact position	6h	
Normal current(A)	16A	32A
No.poles	3P+E	
Dimension(mm)	a	95 120
	b	102 112
	c	124 143
	d	64.2 90.2
	e	77.5 79
	e1	88 98.5
Cable nominal cross-section area(mm ²)	1-2.5	2.5-6



FNP3-115F
FNP3-125F
电流 Current(A):16A 32A
电压 Voltage(V):200-346V~
240-415V~
防护等级 Protection degree:IP67

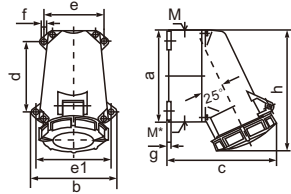

Earth contact position	6h	
Normal current(A)	16A	32A
No.poles	3P+N+E	
Dimension(mm)	a	95 120
	b	102 112
	c	129 150
	d	64.2 90.2
	e	77.5 79
	e1	88 98.5
Cable nominal cross-section area(mm ²)	1-2.5	2.5-6

电流 16A/32A 防水等级 IP44
FNP1 1代 经济型连接器



FNP1-213-4
FNP1-223-4
电流 Current(A):16A 32A
电压 Voltage(V):110-130V~
防护等级 Protection degree:IP44

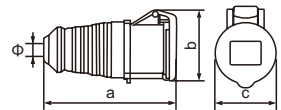

Earth contact position	4h	
Normal current(A)	16A	32A
No.poles	2P+E	
Dimension(mm)	a	131 150
	b	70 92
	c	51 65
	Φ	6-18 8-20
	Φ	6-18 8-20
Cable nominal cross-section area(mm ²)	1-2.5	2.5-6



FNP1-213
FNP1-223
电流 Current(A):16A 32A
电压 Voltage(V):200-250V~
防护等级 Protection degree:IP44

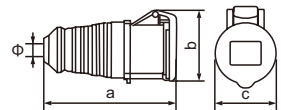

Earth contact position	6h	
Normal current(A)	16A	32A
No.poles	2P+E	
Dimension(mm)	a	131 150
	b	70 92
	c	51 65
	Φ	6-18 8-20
	Φ	6-18 8-20
Cable nominal cross-section area(mm ²)	1-2.5	2.5-6

Earth contact position	6h	
Normal current(A)	16A	32A
No.poles	3P+E	
Dimension(mm)	a	130 150
	b	78 92
	c	56 64.5
	Φ	6-18 8-20
	Φ	6-18 8-20
Cable nominal cross-section area(mm ²)	1-2.5	2.5-6

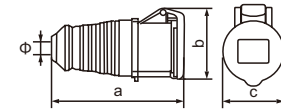

FNP1-214
FNP1-224
电流 Current(A):16A 32A
电压 Voltage(V):380-415V~
防护等级 Protection degree:IP44



Earth contact position	6h	
Normal current(A)	16A	32A
No.poles	3P+N+E	
Dimension(mm)	a	140 154
	b	92 102
	c	63 70.5
	Φ	8-20 8-20
	Φ	8-20 8-20
Cable nominal cross-section area(mm ²)	1-2.5	2.5-6

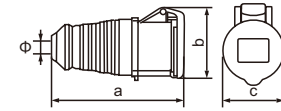

FNP1-215
FNP1-225
电流 Current(A):16A 32A
电压 Voltage(V):200-346V~
240-415V~
防护等级 Protection degree:IP44



Earth contact position	9h	
Normal current(A)	16A	32A
No.poles	2P+E	
Dimension(mm)	a	150 182
	b	70 92
	c	51 65
	Φ	7-16 7-20
	Φ	7-16 7-20
Cable nominal cross-section area(mm ²)	1-2.5	2.5-6

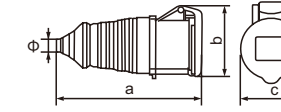

FNP1-213L-9
FNP1-223L-9
电流 Current(A):16A 32A
电压 Voltage(V):380-415V~
防护等级 Protection degree:IP44



Earth contact position	9h	
Normal current(A)	16A	32A
No.poles	3P+E	
Dimension(mm)	a	149 182
	b	78 92
	c	56 64.4
	Φ	7-16 7-20
	Φ	7-16 7-20
Cable nominal cross-section area(mm ²)	1-2.5	2.5-6

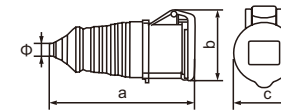

FNP1-214L-9
FNP1-224L-9
电流 Current(A):16A 32A
电压 Voltage(V):220-240V~
防护等级 Protection degree:IP44



Earth contact position	6h	
Normal current(A)	16A	32A
No.poles	2P+E	
Dimension(mm)	a	150 182
	b	70 92
	c	51 65
	Φ	7-20 7-20
	Φ	7-20 7-20
Cable nominal cross-section area(mm ²)	1-2.5	2.5-6

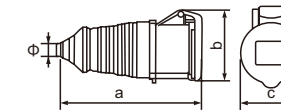

FNP1-213L
FNP1-223L
电流 Current(A):16A 32A
电压 Voltage(V):200-250V~
防护等级 Protection degree:IP44



Earth contact position	6h	
Normal current(A)	16A	32A
No.poles	3P+E	
Dimension(mm)	a	150 182
	b	78 92
	c	56 64.4
	Φ	7-20 7-20
	Φ	7-20 7-20
Cable nominal cross-section area(mm ²)	1-2.5	2.5-6

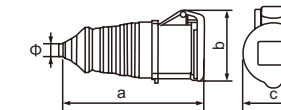

FNP1-214L
FNP1-224L
电流 Current(A):16A 32A
电压 Voltage(V):380-415V~
防护等级 Protection degree:IP44





FNP1-215L
FNP1-225L
电流 Current(A):16A 32A
电压 Voltage(V):200-346V~
240-415V~
防护等级 Protection degree:IP44

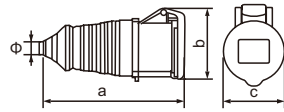

Earth contact position	6h	
Normal current(A)	16A	32A
No.poles	3P+N+E	
Dimension(mm)	a	171 186
	b	92 102
	c	63 70.5
	Φ	7-20 7-20
Cable nominal cross-section area(mm ²)	1-2.5	2.5-6

电流 63A/125A 防水等级 IP67
FNP1代 经济型连接器



FNP1-233
FNP1-243
电流 Current(A):63A 125A
电压 Voltage(V):200-250V~
防护等级 Protection degree:IP67

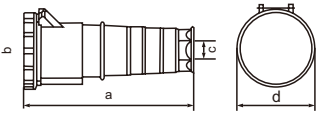

Earth contact position	6h	
Normal current(A)	63A	125A
No.poles	2P+E	
Dimension(mm)	a	240 307
	b	115 128
	c	16-38 30-64
	d	110 122
Cable nominal cross-section area(mm ²)	6-16	16-50



FNP1-234
FNP1-244
电流 Current(A):63A 125A
电压 Voltage(V):380-415V~
防护等级 Protection degree:IP67

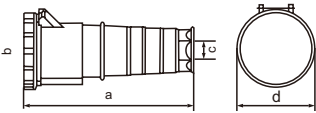

Earth contact position	6h	
Normal current(A)	63A	125A
No.poles	3P+E	
Dimension(mm)	a	240 307
	b	115 128
	c	16-38 30-64
	d	110 122
Cable nominal cross-section area(mm ²)	6-16	16-50



FNP1-235
FNP1-245
电流 Current(A):63A 125A
电压 Voltage(V):200-346V~
240-415V~
防护等级 Protection degree:IP67

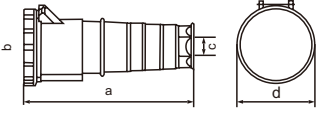

Earth contact position	6h	
Normal current(A)	63A	125A
No.poles	3P+E	
Dimension(mm)	a	240 307
	b	115 128
	c	16-38 30-64
	d	110 122
Cable nominal cross-section area(mm ²)	6-16	16-50

电流 16A/32A 防水等级 IP44
FNP2代 螺旋快速安装型连接器

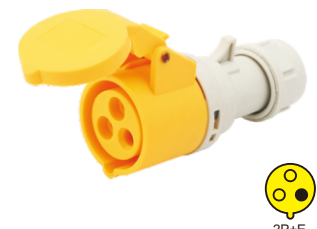

FNP2-213-4
FNP2-223-4
电流 Current(A):16A 32A
电压 Voltage(V):110-130V~
防护等级 Protection degree:IP44

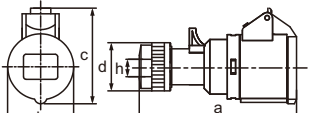

Earth contact position	4h	
Normal current(A)	16A	32A
No.poles	2P+E	
Dimension(mm)	a	127 147
	b	51 65.5
	c	77 96.5
	d	42.5 55.5
Cable nominal cross-section area(mm ²)	1-2.5	2.5-6



FNP2-213
FNP2-223
电流 Current(A):16A 32A
电压 Voltage(V):200-250V~
防护等级 Protection degree:IP44

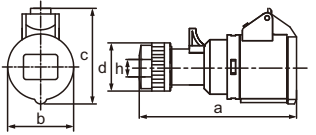

Earth contact position	6h	
Normal current(A)	16A	32A
No.poles	2P+E	
Dimension(mm)	a	127 147
	b	51 65.5
	c	77 96.5
	d	42.5 55.5
Cable nominal cross-section area(mm ²)	1-2.5	2.5-6

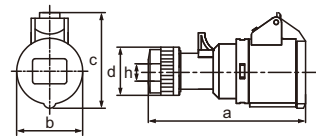

FNP2-214
FNP2-224
电流 Current(A):16A 32A
电压 Voltage(V):380-415V~
防护等级 Protection degree:IP44



Earth contact position	6h	
Normal current(A)	16A	32A
No.poles	3P+E	
Dimension(mm)	a	131.5 152
	b	57.5 65.5
	c	82.5 96.5
	d	42.5 55.5
Cable nominal cross-section area(mm ²)	1-2.5	2.5-6

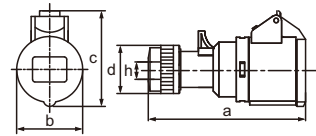

FNP2-215
FNP2-225
电流 Current(A):16A 32A
电压 Voltage(V):200-346V~
240-415V~
防护等级 Protection degree:IP44



Earth contact position	6h	
Normal current(A)	16A	32A
No.poles	3P+N+E	
Dimension(mm)	a	138 159
	b	64 72
	c	91.5 101.5
	d	42.5 55.5
Cable nominal cross-section area(mm ²)	1-2.5	2.5-6

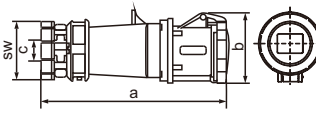

FNP2-213F-4
FNP2-223F-4
电流 Current(A):16A 32A
电压 Voltage(V):110-130V~
防护等级 Protection degree:IP67

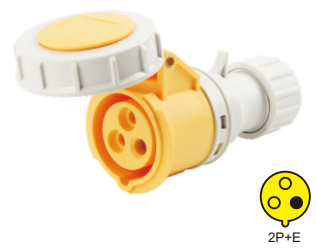

Earth contact position	4h	
Normal current(A)	16A	32A
No.poles	2P+E	
Dimension(mm)	a	141 172
	b	78 96
	c	6-15 10-20
	sw	44 54
Cable nominal cross-section area(mm ²)	1-2.5	2.5-6

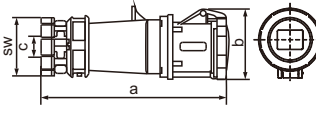

FNP2-213F
FNP2-223F
电流 Current(A):16A 32A
电压 Voltage(V):200-250V~
防护等级 Protection degree:IP67



Earth contact position	6h	
Normal current(A)	16A	32A
No.poles	2P+E	
Dimension(mm)	a	141 172
	b	78 96
	c	6-15 10-20
	sw	44 54
Cable nominal cross-section area(mm ²)	1-2.5	2.5-6

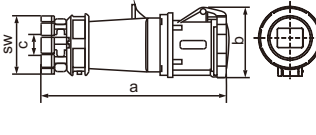

FNP2-214F
FNP2-224F
电流 Current(A):16A 32A
电压 Voltage(V):380-415V~
防护等级 Protection degree:IP67



Earth contact position	6h	
Normal current(A)	16A	32A
No.poles	3P+E	
Dimension(mm)	a	146 172
	b	85 93
	c	6-15 10-20
	sw	44 54
Cable nominal cross-section area(mm ²)	1-2.5	2.5-6

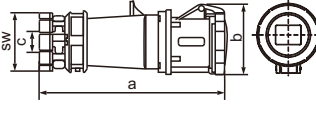

FNP2-215F
FNP2-225F
电流 Current(A):16A 32A
电压 Voltage(V):200-346V~
240-415V~
防护等级 Protection degree:IP67



Earth contact position	6h	
Normal current(A)	16A	32A
No.poles	3P+N+E	
Dimension(mm)	a	155 181
	b	92 105
	c	6-15 10-20
	sw	44 54
Cable nominal cross-section area(mm ²)	1-2.5	2.5-6

电流 16A/32A 防水等级 IP67
FNP2代 螺旋快速安装型连接器

电流 63A/125A 防水等级 IP67
FNP2 2代 螺旋快速安装型连接器



FNP2-233F
FNP2-243F
电流 Current(A):63A 125A
电压 Voltage(V):200-250V~
防护等级 Protection degree:IP67

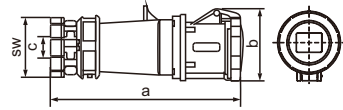

Earth contact position	6h	
Normal current(A)	63A	125A
No.poles	2P+E	
Dimension(mm)	a	275 290
	b	114 129
	c	23 31
	sw	63 79
Cable nominal cross-section area(mm ²)	6-16	16-50



FNP2-234F
FNP2-244F
电流 Current(A):63A 125A
电压 Voltage(V):380-415V~
防护等级 Protection degree:IP67

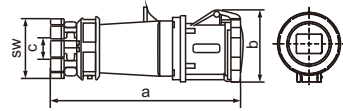

Earth contact position	6h	
Normal current(A)	63A	125A
No.poles	3P+E	
Dimension(mm)	a	275 290
	b	114 129
	c	23 31
	sw	63 79
Cable nominal cross-section area(mm ²)	6-16	16-50



FNP2-235F
FNP2-245F
电流 Current(A):63A 125A
电压 Voltage(V):200-346V~
240-415V~
防护等级 Protection degree:IP67

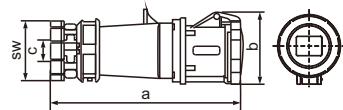

Earth contact position	6h	
Normal current(A)	63A	125A
No.poles	3P+N+E	
Dimension(mm)	a	275 290
	b	114 129
	c	23 31
	sw	63 79
Cable nominal cross-section area(mm ²)	6-16	16-50

电流 16A/32A 防水等级 IP44
FNP3 3代 高端型连接器



FNP3-213-4
FNP3-223-4
电流 Current(A):16A 32A
电压 Voltage(V):110-130V~
防护等级 Protection degree:IP44

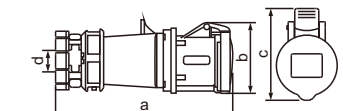

Earth contact position	4h	
Normal current(A)	16A	32A
No.poles	2P+E	
Dimension(mm)	a	155 200
	b	52 65
	c	57 72
Cable nominal cross-section area(mm ²)	1-2.5	2.5-6



FNP3-213
FNP3-223
电流 Current(A):16A 32A
电压 Voltage(V):200-250V~
防护等级 Protection degree:IP44

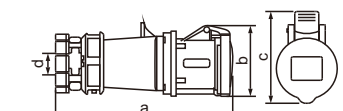

Earth contact position	6h	
Normal current(A)	16A	32A
No.poles	2P+E	
Dimension(mm)	a	155 200
	b	52 65
	c	57 72
Cable nominal cross-section area(mm ²)	1-2.5	2.5-6



FNP3-214
FNP3-224
电流 Current(A):16A 32A
电压 Voltage(V):380-415V~
防护等级 Protection degree:IP44

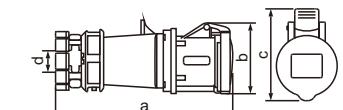

Earth contact position	6h	
Normal current(A)	16A	32A
No.poles	3P+E	
Dimension(mm)	a	157 200
	b	52 65
	c	62 72
	sw	63 79
Cable nominal cross-section area(mm ²)	1-2.5	2.5-6

Earth contact position	6h	
Normal current(A)	16A	32A
No.poles	3P+N+E	
Dimension(mm)	a	162 200
	b	52 71
	c	69 80
Cable nominal cross-section area(mm ²)	1-2.5	2.5-6

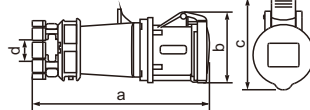

FNP3-215
FNP3-225
电流 Current(A):16A 32A
电压 Voltage(V):200-346V~
240-415V~
防护等级 Protection degree:IP44



Earth contact position	4h	
Normal current(A)	16A	32A
No.poles	2P+E	
Dimension(mm)	a	160 203
	b	54.7 67.5
	c	105.5 135.7
Cable nominal cross-section area(mm ²)	1-2.5	2.5-6

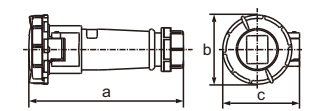

FNP3-213F-4
FNP3-223F-4
电流 Current(A):16A 32A
电压 Voltage(V):110-130V~
防护等级 Protection degree:IP67



Earth contact position	6h	
Normal current(A)	16A	32A
No.poles	2P+E	
Dimension(mm)	a	160 203
	b	54.7 67.5
	c	105.5 135.7
Cable nominal cross-section area(mm ²)	1-2.5	2.5-6

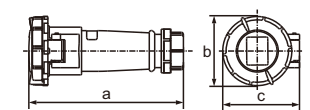

FNP3-213F
FNP3-223F
电流 Current(A):16A 32A
电压 Voltage(V):200-250V~
防护等级 Protection degree:IP67



Earth contact position	6h	
Normal current(A)	16A	32A
No.poles	3P+E	
Dimension(mm)	a	163 206
	b	56 68
	c	111 138
Cable nominal cross-section area(mm ²)	1-2.5	2.5-6

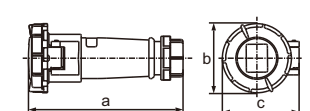

FNP3-214F
FNP3-224F
电流 Current(A):16A 32A
电压 Voltage(V):380-415V~
防护等级 Protection degree:IP67

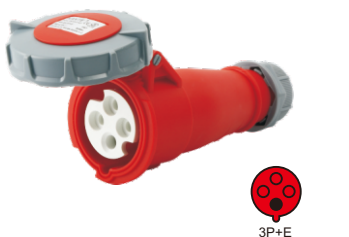

Earth contact position	6h	
Normal current(A)	16A	32A
No.poles	3P+N+E	
Dimension(mm)	a	163 206
	b	57 68
	c	111 138
Cable nominal cross-section area(mm ²)	1-2.5	2.5-6

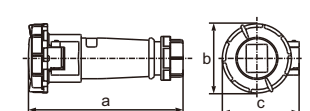

FNP3-215F
FNP3-225F
电流 Current(A):16A 32A
电压 Voltage(V):200-346V~
240-415V~
防护等级 Protection degree:IP67



Earth contact position	4h	
Normal current(A)	16A	32A
No.poles	2P+E	
Dimension(mm)	a	74 89
	b	73 87
	c×d	70 70
	e	56 56
	g×f	57 57
	h	26 29
	sw	63 79
	Φe	16 16
Cable nominal cross-section area(mm ²)	1-2.5	2.5-6

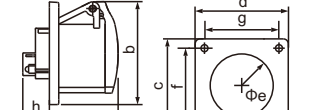

FNP1-313-4
FNP1-323-4
电流 Current(A):16A 32A
电压 Voltage(V):110-130V~
防护等级 Protection degree:IP44



电流 16A/32A 防水等级 IP67
FNP3 3代 高端型连接器

电流 16A/32A 防水等级 IP44
FNP1 1代 经济型暗装插座



**FNP1-313
FNP1-323**

电流 Current(A):16A 32A
电压 Voltage(V):200-250V~
防护等级 Protection degree:IP44

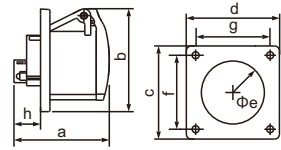

Earth contact position	6h		
Normal current(A)	16A	32A	
No.poles	2P+E		
Dimension(mm)	a	74	89
	b	73	87
	cxd	70	70
	e	56	56
	gxf	57	57
	h	26	29
	Cable nominal cross-section area(mm ²)	1-2.5	2.5-6

Earth contact position	4h		
Normal current(A)	16A	32A	
No.poles	2P+E		
Dimension(mm)	axb	70.5	70.5
	cxd	56	56
	e	28	31
	f	50	62.5
	g	5.4	5.4
	h	52	56
	i	68	87
Cable nominal cross-section area(mm ²)	1-2.5	2.5-6	

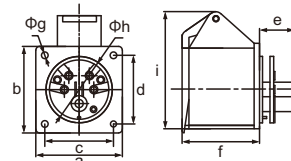

**FNP2-313-4
FNP2-323-4**

电流 Current(A):16A 32A
电压 Voltage(V):110-130V~
防护等级 Protection degree:IP44



**FNP1-314
FNP1-324**

电流 Current(A):16A 32A
电压 Voltage(V):380-415V~
防护等级 Protection degree:IP44

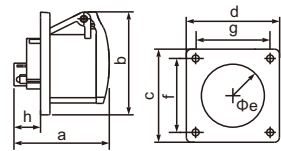

Earth contact position	6h		
Normal current(A)	16A	32A	
No.poles	3P+E		
Dimension(mm)	a	74	89
	b	73	87
	cxd	70	70
	e	56	56
	gxf	57	57
	h	26	29
	Cable nominal cross-section area(mm ²)	1-2.5	2.5-6

Earth contact position	6h		
Normal current(A)	16A	32A	
No.poles	2P+E		
Dimension(mm)	axb	70.5	70.5
	cxd	56	56
	e	28	31
	f	50	62.5
	g	5.4	5.4
	h	52	56
	i	68	87
Cable nominal cross-section area(mm ²)	1-2.5	2.5-6	

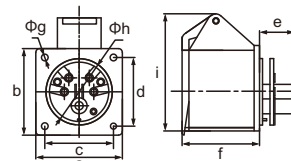

**FNP2-313
FNP2-323**

电流 Current(A):16A 32A
电压 Voltage(V):200-250V~
防护等级 Protection degree:IP44



**FNP1-315
FNP1-325**

电流 Current(A):16A 32A
电压 Voltage(V):200-346V~
240-415V~
防护等级 Protection degree:IP44

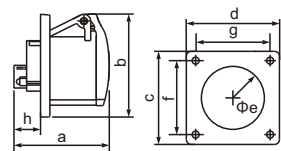

Earth contact position	6h		
Normal current(A)	16A	32A	
No.poles	3P+N+E		
Dimension(mm)	a	74	89
	b	73	87
	cxd	70	70
	e	56	56
	gxf	57	57
	h	26	29
	Cable nominal cross-section area(mm ²)	1-2.5	2.5-6

Earth contact position	6h		
Normal current(A)	16A	32A	
No.poles	3P+E		
Dimension(mm)	axb	70.5	70.5
	cxd	56	56
	e	28	31
	f	51	63
	g	5.4	5.4
	h	54	56
	i	77	88
Cable nominal cross-section area(mm ²)	1-2.5	2.5-6	

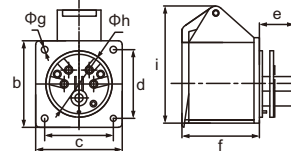

**FNP2-314
FNP2-324**

电流 Current(A):16A 32A
电压 Voltage(V):380-415V~
防护等级 Protection degree:IP44



**FNP1-333
FNP1-343**

电流 Current(A):63A 125A
电压 Voltage(V):200-250V~
防护等级 Protection degree:IP67

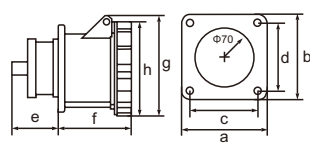

Earth contact position	6h		
Normal current(A)	63A	125A	
No.poles	2P+E		
Dimension(mm)	axb	100	120
	cxd	80	100
	e	55	67
	f	85	93
	g	114	130
	h	108	122
	Cable nominal cross-section area(mm ²)	6-16	16-50

Earth contact position	6h		
Normal current(A)	16A	32A	
No.poles	3P+N+E		
Dimension(mm)	axb	70.5	70.5
	cxd	56	56
	e	28	31
	f	51	63
	g	5.4	5.4
	h	55	56
	i	86	96
Cable nominal cross-section area(mm ²)	1-2.5	2.5-6	

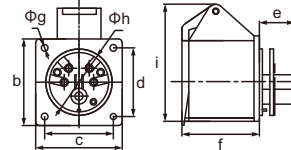

**FNP2-315
FNP2-325**

电流 Current(A):16A 32A
电压 Voltage(V):200-346V~
240-415V~
防护等级 Protection degree:IP44



**FNP1-334
FNP1-344**

电流 Current(A):63A 125A
电压 Voltage(V):380-415V~
防护等级 Protection degree:IP67

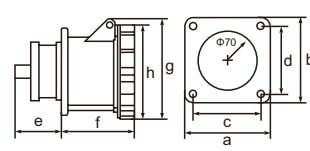

Earth contact position	6h		
Normal current(A)	63A	125A	
No.poles	2P+E		
Dimension(mm)	axb	100	120
	cxd	80	100
	e	55	67
	f	85	93
	g	114	130
	h	108	122
	Cable nominal cross-section area(mm ²)	6-16	16-50

Earth contact position	4h		
Normal current(A)	16A	32A	
No.poles	2P+E		
Dimension(mm)	axb	75	75
	cxd	60	60
	e	16	20
	f	56	65
	g	83	97
	h	65	65
	i	5.5	5.5
Cable nominal cross-section area(mm ²)	1-2.5	2.5-6	

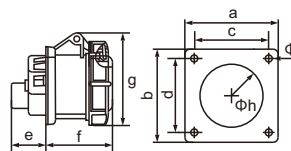

**FNP2-313F-4
FNP2-323F-4**

电流 Current(A):16A 32A
电压 Voltage(V):110-130V~
防护等级 Protection degree:IP67



**FNP1-335
FNP1-345**

电流 Current(A):63A 125A
电压 Voltage(V):200-346V~
240-415V~
防护等级 Protection degree:IP67

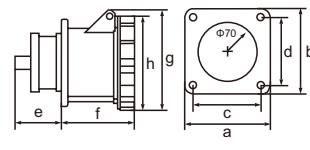

Earth contact position	6h		
Normal current(A)	63A	125A	
No.poles	2P+E		
Dimension(mm)	axb	100	120
	cxd	80	100
	e	55	67
	f	85	93
	g	114	130
	h	108	122
	Cable nominal cross-section area(mm ²)	6-16	16-50

Earth contact position	6h		
Normal current(A)	16A	32A	
No.poles	2P+E		
Dimension(mm)	axb	75	75
	cxd	60	60
	e	16	20
	f	56	65
	g	83	97
	h	65	65
	i	5.5	5.5
Cable nominal cross-section area(mm ²)	1-2.5	2.5-6	

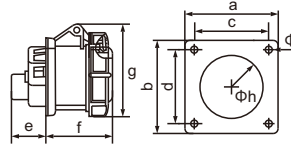

**FNP2-313F
FNP2-323F**

电流 Current(A):16A 32A
电压 Voltage(V):200-250V~
防护等级 Protection degree:IP67



电流 16A/32A 防水等级 IP44
FNP2代 螺旋快速安装型暗装插座

电流 16A/32A 防水等级 IP67
FNP2代 螺旋快速安装型暗装插座

电流 63A/125A 防水等级 IP67
FNP1代 经济型暗装插座



**FNP2-314F
FNP2-324F**

电流 Current(A):16A 32A
电压 Voltage(V):380-415V~
防护等级 Protection degree:IP67

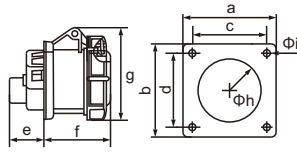

Earth contact position	6h		
Normal current(A)	16A	32A	
No.poles	3P+E		
Dimension(mm)	a x b	75 75	
	c x d	60 60	
	e	16 20	
	f	56 65	
	g	89 97	
	h	65 65	
	i	5.5 5.5	
	Cable nominal cross-section area(mm ²)		1-2.5 2.5-6



**FNP2-315F
FNP2-325F**

电流 Current(A):16A 32A
电压 Voltage(V):200-346V~
~V211-0A5
防护等级 Protection degree:IP67

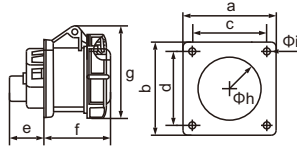

Earth contact position	6h		
Normal current(A)	16A	32A	
No.poles	3P+N+E		
Dimension(mm)	a x b	75 75	
	c x d	60 60	
	e	16 20	
	f	56 67	
	g	92 105	
	h	65 65	
	i	5.5 5.5	
	Cable nominal cross-section area(mm ²)		1-2.5 2.5-6



**FNP2-333F
FNP2-343F**

电流 Current(A):63A 125A
电压 Voltage(V):200-250V~
防护等级 Protection degree:IP67

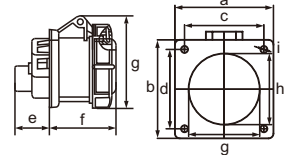

Earth contact position	6h		
Normal current(A)	63A	125A	
No.poles	2P+E		
Dimension(mm)	a x b	100 120	
	c x d	80 100	
	e	35 45	
	f	98 104	
	g	80 100	
	h	80 100	
	Cable nominal cross-section area(mm ²)		6-16 16-50



**FNP2-334F
FNP2-344F**

电流 Current(A):63A 125A
电压 Voltage(V):380-415V~
防护等级 Protection degree:IP67

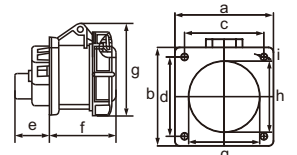

Earth contact position	6h		
Normal current(A)	63A	125A	
No.poles	3P+E		
Dimension(mm)	a x b	100 120	
	c x d	80 100	
	e	35 45	
	f	98 104	
	g	80 100	
	h	80 100	
	Cable nominal cross-section area(mm ²)		6-16 16-50



**FNP2-335F
FNP2-345F**

电流 Current(A):63A 125A
电压 Voltage(V):200-346V~
240-415V~
防护等级 Protection degree:IP67

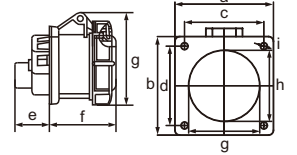

Earth contact position	6h		
Normal current(A)	63A	125A	
No.poles	3P+N+E		
Dimension(mm)	a x b	100 120	
	c x d	80 100	
	e	35 45	
	f	98 104	
	g	80 100	
	h	80 100	
	Cable nominal cross-section area(mm ²)		6-16 16-50



**FNP3-313-4
FNP3-323-4**

电流 Current(A):16A 32A
电压 Voltage(V):110-130V~
防护等级 Protection degree:IP44

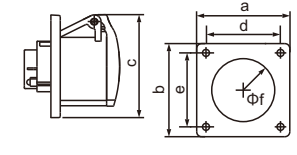

Earth contact position	4h	
Normal current(A)	16A	32A
No.poles	2P+E	
Dimension(mm)	a	76 76
	b	76 85
	c	83 99
	d x e	60 60
	f	65 65
	Cable nominal cross-section area(mm ²)	

Earth contact position	6h	
Normal current(A)	16A	32A
No.poles	2P+E	
Dimension(mm)	a	76 76
	b	76 85
	c	83 99
	d x e	60 60
	f	65 65
	Cable nominal cross-section area(mm ²)	

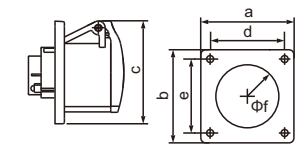

**FNP3-313
FNP3-323**

电流 Current(A):16A 32A
电压 Voltage(V):200-250V~
防护等级 Protection degree:IP44



Earth contact position	6h	
Normal current(A)	16A	32A
No.poles	3P+E	
Dimension(mm)	a	76 76
	b	76 85
	c	83 99
	d x e	60 60
	f	65 65
	Cable nominal cross-section area(mm ²)	

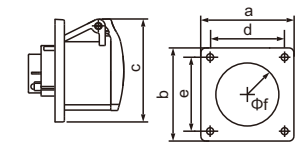

**FNP3-314
FNP3-324**

电流 Current(A):16A 32A
电压 Voltage(V):380-415V~
防护等级 Protection degree:IP44



Earth contact position	6h	
Normal current(A)	16A	32A
No.poles	3P+N+E	
Dimension(mm)	a	76 76
	b	76 85
	c	95 105
	d x e	60 60
	f	65 65
	Cable nominal cross-section area(mm ²)	

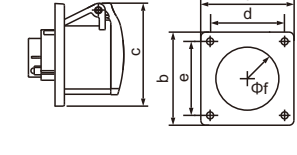

**FNP3-315
FNP3-325**

电流 Current(A):16A 32A
电压 Voltage(V):200-346V~
240-415V~
防护等级 Protection degree:IP44



Earth contact position	4h		
Normal current(A)	16A	32A	
No.poles	2P+E		
Dimension(mm)	a	76 76	
	b	72 85	
	c x d	60 60	
	e	83 99	
	Cable nominal cross-section area(mm ²)		1-2.5 2.5-6

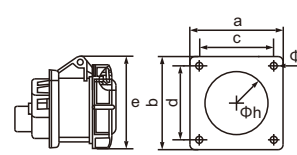

**FNP3-313F-4
FNP3-323F-4**

电流 Current(A):16A 32A
电压 Voltage(V):110-130V~
防护等级 Protection degree:IP67



Earth contact position	6h		
Normal current(A)	16A	32A	
No.poles	2P+E		
Dimension(mm)	a	76 76	
	b	72 85	
	c x d	60 60	
	e	83 99	
	Cable nominal cross-section area(mm ²)		1-2.5 2.5-6

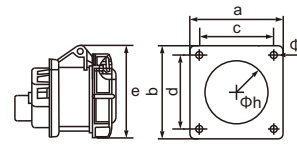

**FNP3-313F
FNP3-323F**

电流 Current(A):16A 32A
电压 Voltage(V):200-250V~
防护等级 Protection degree:IP67



Earth contact position	6h		
Normal current(A)	16A	32A	
No.poles	3P+E		
Dimension(mm)	a	76 76	
	b	76 85	
	c x d	60 60	
	e	88 99	
	Cable nominal cross-section area(mm ²)		1-2.5 2.5-6

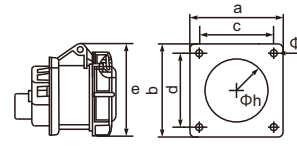

**FNP3-314F
FNP3-324F**

电流 Current(A):16A 32A
电压 Voltage(V):380-415V~
防护等级 Protection degree:IP67



电流 16A/32A 防水等级 IP44
FNP1 一代 经济型暗装斜插座



FNP3-315F
FNP3-325F
电流 Current(A):16A 32A
电压 Voltage(V):200-346V~
240-415V~
防护等级 Protection degree:IP67

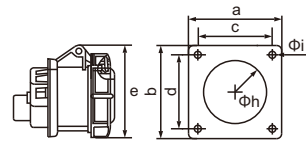

Earth contact position	6h	
Normal current(A)	16A	32A
No.poles	3P+N+E	
Dimension(mm)	a	76
	b	76
	c	60
	d	60
	e	95
Cable nominal cross-section area(mm ²)		1-2.5 2.5-6



FNP1-413-4
FNP1-423-4
电流 Current(A):16A 32A
电压 Voltage(V):110-130V~
防护等级 Protection degree:IP44

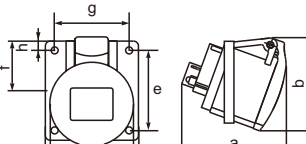

Earth contact position	4h	
Normal current(A)	16A	32A
No.poles	2P+E	
Dimension(mm)	a	76
	b	68
	c	62
	d	53
	e	58
	f	49
	g	47
	h	10.5
Cable nominal cross-section area(mm ²)		1-2.5 2.5-6



FNP1-413
FNP1-423
电流 Current(A):16A 32A
电压 Voltage(V):200-250V~
防护等级 Protection degree:IP44

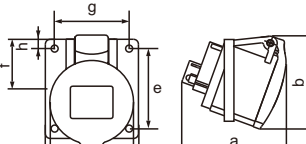

Earth contact position	6h	
Normal current(A)	16A	32A
No.poles	2P+E	
Dimension(mm)	a	76
	b	68
	c	62
	d	53
	e	58
	f	49
	g	47
	h	10.5
Cable nominal cross-section area(mm ²)		1-2.5 2.5-6



FNP1-414
FNP1-424
电流 Current(A):16A 32A
电压 Voltage(V):380-415V~
防护等级 Protection degree:IP44

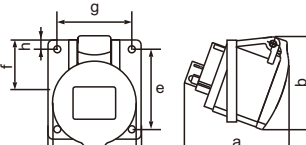

Earth contact position	6h	
Normal current(A)	16A	32A
No.poles	3P+E	
Dimension(mm)	a	80
	b	85
	c	75
	d	59
	e	66
	f	61
	g	60
	h	13
Cable nominal cross-section area(mm ²)		1-2.5 2.5-6



FNP1-415
FNP1-425
电流 Current(A):16A 32A
电压 Voltage(V):200-346V~
240-415V~
防护等级 Protection degree:IP44

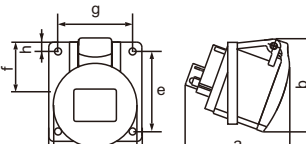

Earth contact position	6h	
Normal current(A)	16A	32A
No.poles	3P+N+E	
Dimension(mm)	a	80
	b	86
	c	75
	d	64
	e	74
	f	61
	g	60
	h	13
Cable nominal cross-section area(mm ²)		1-2.5 2.5-6



FNP1-433
FNP1-443
电流 Current(A):63A 125A
电压 Voltage(V):200-250V~
防护等级 Protection degree:IP67

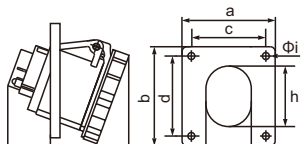

Earth contact position	6h	
Normal current(A)	63A	125A
No.poles	2P+E	
Dimension(mm)	a	100
	b	113
	c	80
	d	92
	e	73
	f	83
	g	90
	h	124
	i	6
Cable nominal cross-section area(mm ²)		6-16 16-50

电流 16A/32A 防水等级 IP44
FNP2 二代 螺旋快速安装型暗装斜插座

Earth contact position	6h	
Normal current(A)	63A	125A
No.poles	3P+N+E	
Dimension(mm)	a	100
	b	113
	c	80
	d	92
	e	73
	f	83
	g	90
	h	124
	i	6
	Cable nominal cross-section area(mm ²)	

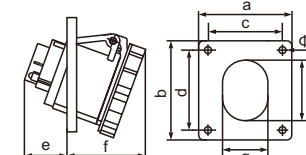

FNP1-434
FNP1-444
电流 Current(A):63A 125A
电压 Voltage(V):380-415V~
防护等级 Protection degree:IP67



Earth contact position	6h	
Normal current(A)	63A	125A
No.poles	3P+N+E	
Dimension(mm)	a	100
	b	113
	c	80
	d	92
	e	73
	f	83
	g	90
	h	124
	i	6
	Cable nominal cross-section area(mm ²)	

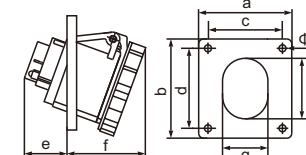

FNP1-435
FNP1-445
电流 Current(A):63A 125A
电压 Voltage(V):200-346V~
240-415V~
防护等级 Protection degree:IP67



Earth contact position	4h	
Normal current(A)	16A	32A
No.poles	2P+E	
Dimension(mm)	a	56
	b	56
	c	50
	d	35
Cable nominal cross-section area(mm ²)		1-2.5 2.5-6

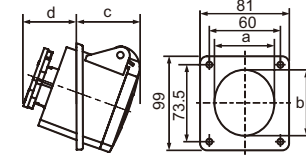

FNP2-413-4
FNP2-423-4
电流 Current(A):16A 32A
电压 Voltage(V):110-130V~
防护等级 Protection degree:IP44



Earth contact position	6h	
Normal current(A)	16A	32A
No.poles	2P+E	
Dimension(mm)	a	56
	b	56
	c	50
	d	35
Cable nominal cross-section area(mm ²)		1-2.5 2.5-6

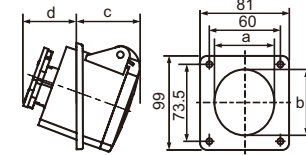

FNP2-413
FNP2-423
电流 Current(A):16A 32A
电压 Voltage(V):200-250V~
防护等级 Protection degree:IP44



Earth contact position	6h	
Normal current(A)	16A	32A
No.poles	3P+N+E	
Dimension(mm)	a	60
	b	60
	c	52
	d	38
Cable nominal cross-section area(mm ²)		1-2.5 2.5-6

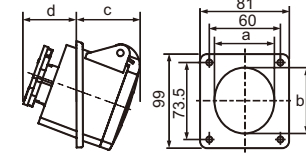

FNP2-414
FNP2-424
电流 Current(A):16A 32A
电压 Voltage(V):380-415V~
防护等级 Protection degree:IP44



Earth contact position	6h	
Normal current(A)	16A	32A
No.poles	3P+N+E	
Dimension(mm)	a	63
	b	72
	c	53
	d	41
Cable nominal cross-section area(mm ²)		1-2.5 2.5-6

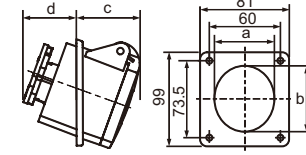

FNP2-415
FNP2-425
电流 Current(A):16A 32A
电压 Voltage(V):200-346V~
240-415V~
防护等级 Protection degree:IP44



电流 63A/125A 防水等级 IP67
FNP1 一代 经济型暗装斜插座

电流 16A/32A 防水等级 IP67
FNP2 2代 螺旋快速安装型暗装斜插座



**FNP2-413F-4
FNP2-423F-4**

电流 Current(A):16A 32A
电压 Voltage(V):110-130V~
防护等级 Protection degree:IP67

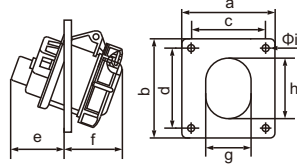

Earth contact position	4h	
Normal current(A)	16A	32A
No.poles	2P+E	
Dimension(mm)	a	80
	b	98
	c	60
	d	73
	e	34
	f	49
	g	57
	h	62
	i	65
	j	80
Cable nominal cross-section area(mm ²)	1-2.5	2.5-6



**FNP2-413F
FNP2-423F**

电流 Current(A):16A 32A
电压 Voltage(V):200-250V~
防护等级 Protection degree:IP67

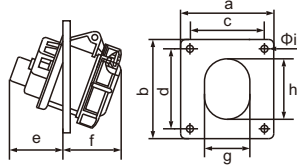

Earth contact position	6h	
Normal current(A)	16A	32A
No.poles	2P+E	
Dimension(mm)	a	80
	b	98
	c	60
	d	73
	e	34
	f	49
	g	57
	h	62
	i	65
	j	80
Cable nominal cross-section area(mm ²)	1-2.5	2.5-6



**FNP2-414F
FNP2-424F**

电流 Current(A):16A 32A
电压 Voltage(V):380-415V~
防护等级 Protection degree:IP67

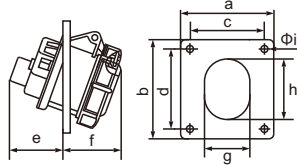

Earth contact position	6h	
Normal current(A)	16A	32A
No.poles	3P+E	
Dimension(mm)	a	80
	b	98
	c	60
	d	73
	e	34
	f	49
	g	57
	h	62
	i	65
	j	80
Cable nominal cross-section area(mm ²)	1-2.5	2.5-6



**FNP2-415F
FNP2-425F**

电流 Current(A):16A 32A
电压 Voltage(V):200-346V~
240-415V~
防护等级 Protection degree:IP67

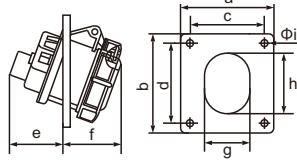

Earth contact position	6h	
Normal current(A)	16A	32A
No.poles	3P+N+E	
Dimension(mm)	a	80
	b	98
	c	60
	d	73
	e	34
	f	49
	g	57
	h	62
	i	65
	j	88
Cable nominal cross-section area(mm ²)	1-2.5	2.5-6



**FNP2-433F
FNP2-443F**

电流 Current(A):63A 125A
电压 Voltage(V):200-250V~
防护等级 Protection degree:IP67

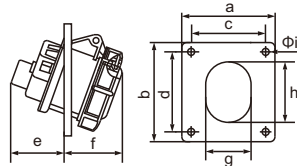

Earth contact position	6h	
Normal current(A)	63A	125A
No.poles	2P+E	
Dimension(mm)	a	101
	b	113
	c	80
	d	89
	e	67
	f	65
	g	80
	h	92
Cable nominal cross-section area(mm ²)	6-16	16-50



**FNP2-434F
FNP2-444F**

电流 Current(A):63A 125A
电压 Voltage(V):380-415V~
防护等级 Protection degree:IP67

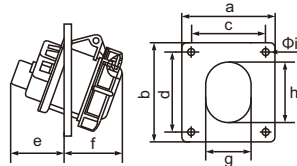

Earth contact position	6h	
Normal current(A)	63A	125A
No.poles	3P+E	
Dimension(mm)	a	101
	b	113
	c	80
	d	89
	e	67
	f	65
	g	80
	h	92
Cable nominal cross-section area(mm ²)	6-16	16-50

Earth contact position	6h	
Normal current(A)	63A	125A
No.poles	3P+N+E	
Dimension(mm)	a	101
	b	113
	c	80
	d	89
	e	67
	f	65
	g	79
	h	95
Cable nominal cross-section area(mm ²)	6-16	16-50

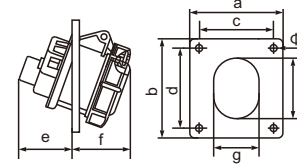

**FNP2-435F
FNP2-445F**

电流 Current(A):63A 125A
电压 Voltage(V):200-346V~
240-415V~
防护等级 Protection degree:IP67



Earth contact position	4h	
Normal current(A)	16A	32A
No.poles	2P+E	
Dimension(mm)	a	64
	b	75
	c	52
	d	60
	e	34
	f	49
	g	50
	h	60
Cable nominal cross-section area(mm ²)	1-2.5	2.5-6

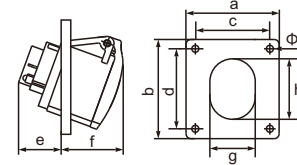

**FNP3-413-4
FNP3-423-4**

电流 Current(A):16A 32A
电压 Voltage(V):110-130V~
防护等级 Protection degree:IP44



Earth contact position	6h	
Normal current(A)	16A	32A
No.poles	2P+E	
Dimension(mm)	a	64
	b	75
	c	52
	d	60
	e	34
	f	49
	g	50
	h	60
Cable nominal cross-section area(mm ²)	1-2.5	2.5-6

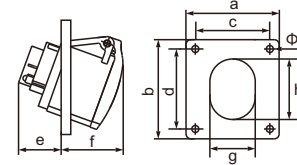

**FNP3-413
FNP3-423**

电流 Current(A):16A 32A
电压 Voltage(V):200-250V~
防护等级 Protection degree:IP44



Earth contact position	6h	
Normal current(A)	16A	32A
No.poles	3P+E	
Dimension(mm)	a	93
	b	101
	c	77
	d	85
	e	34
	f	49
	g	73
	h	86
Cable nominal cross-section area(mm ²)	1-2.5	2.5-6

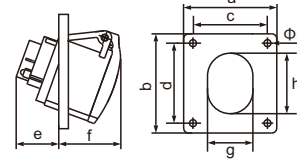

**FNP3-414
FNP3-424**

电流 Current(A):16A 32A
电压 Voltage(V):380-415V~
防护等级 Protection degree:IP44



Earth contact position	6h	
Normal current(A)	16A	32A
No.poles	3P+N+E	
Dimension(mm)	a	93
	b	101
	c	77
	d	85
	e	34
	f	49
	g	73
	h	86
Cable nominal cross-section area(mm ²)	1-2.5	2.5-6

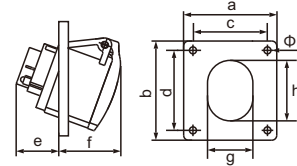

**FNP3-415
FNP3-425**

电流 Current(A):16A 32A
电压 Voltage(V):200-346V~
240-415V~
防护等级 Protection degree:IP44



Earth contact position	4h	
Normal current(A)	16A	32A
No.poles	2P+E	
Dimension(mm)	a	64
	b	75
	c	52
	d	60
	e	50
	f	60
Cable nominal cross-section area(mm ²)	1-2.5	2.5-6

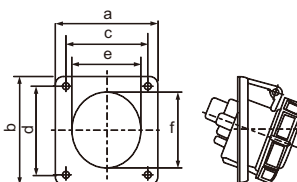

**FNP3-413F-4
FNP3-423F-4**

电流 Current(A):16A 32A
电压 Voltage(V):110-130V~
防护等级 Protection degree:IP67



电流 16A/32A 防水等级 IP44
FNP3 3代 高端型暗装斜插座

电流 16A/32A 防水等级 IP67
FNP3 3代 高端型暗装斜插座



**FNP3-413F
FNP3-423F**

电流 Current(A):16A 32A
电压 Voltage(V):200-250V~
防护等级 Protection degree:IP67

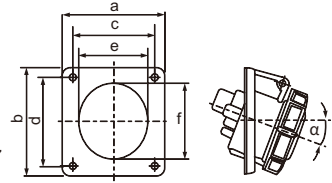

Earth contact position		6h	
Normal current(A)		16A	32A
No.poles		2P+E	
Dimension(mm)	a	64	93
	b	75	101
	c	52	77
	d	60	85
	e	50	73
	f	60	86
Cable nominal cross-section area(mm ²)		1-2.5	2.5-6



**FNP3-414F
FNP3-424F**

电流 Current(A):16A 32A
电压 Voltage(V):380-415V~
防护等级 Protection degree:IP67

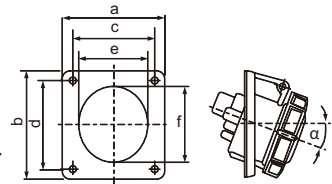

Earth contact position		6h	
Normal current(A)		16A	32A
No.poles		3P+E	
Dimension(mm)	a	93	93
	b	101	101
	c	77	77
	d	85	85
	e	73	73
	f	86	86
Cable nominal cross-section area(mm ²)		1-2.5	2.5-6



**FNP3-415F
FNP3-425F**

电流 Current(A):16A 32A
电压 Voltage(V):200-346V~
240-415V~
防护等级 Protection degree:IP67

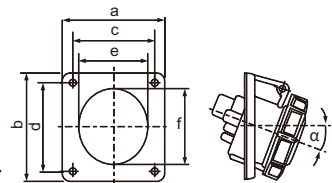

Earth contact position		6h	
Normal current(A)		16A	32A
No.poles		3P+N+E	
Dimension(mm)	a	93	93
	b	101	101
	c	77	77
	d	85	85
	e	73	73
	f	86	86
Cable nominal cross-section area(mm ²)		1-2.5	2.5-6



**FNP1-613
FNP1-623**

电流 Current(A):16A 32A
电压 Voltage(V):200-250V~
防护等级 Protection degree:IP44

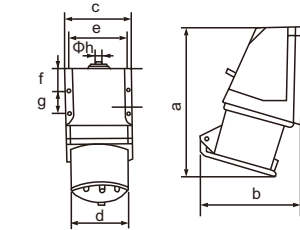

Earth contact position		6h	
Normal current(A)		16A	32A
No.poles		2P+E	
Dimension(mm)	a	130	139
	b	72	81
	c	71	71
	d	43.5	57.5
	e	56	56
	f	20	20
	g	33.5	33.5
	h	5	5
Cable nominal cross-section area(mm ²)		1-2.5	2.5-6



**FNP1-614
FNP1-624**

电流 Current(A):16A 32A
电压 Voltage(V):380-415V~
防护等级 Protection degree:IP44

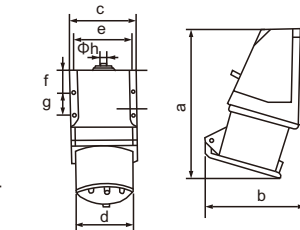

Earth contact position		6h	
Normal current(A)		16A	32A
No.poles		3P+E	
Dimension(mm)	a	130	139
	b	72	81
	c	71	71
	d	50	57
	e	56	56
	f	20	20
	g	33	33.5
	h	5	5
Cable nominal cross-section area(mm ²)		1-2.5	2.5-6



**FNP1-615
FNP1-625**

电流 Current(A):16A 32A
电压 Voltage(V):200-346V~
240-415V~
防护等级 Protection degree:IP44

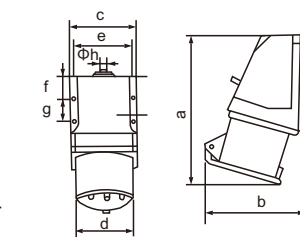

Earth contact position		6h	
Normal current(A)		16A	32A
No.poles		3P+N+E	
Dimension(mm)	a	130	142
	b	72	81
	c	71	71
	d	55	64
	e	56	56
	f	20	20
	g	33.5	33.5
	h	5	5
Cable nominal cross-section area(mm ²)		1-2.5	2.5-6

Earth contact position		6h	
Normal current(A)		63A	125A
No.poles		3P+E	
Dimension(mm)	a	193	220
	b	122	140
	c	157	185
	d	109	130
	e	19	17
	f	6	8
	g	288	330
	h	127	140
Cable nominal cross-section area(mm ²)		6-16	16-50

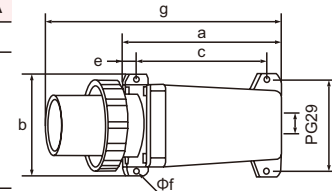

**FNP1-633
FNP1-643**

电流 Current(A):63A 125A
电压 Voltage(V):200-250V~
防护等级 Protection degree:IP67

Earth contact position		6h	
Normal current(A)		63A	125A
No.poles		3P+E	
Dimension(mm)	a	193	220
	b	122	140
	c	157	185
	d	109	130
	e	19	17
	f	6	8
	g	288	330
	h	127	140
Cable nominal cross-section area(mm ²)		6-16	16-50

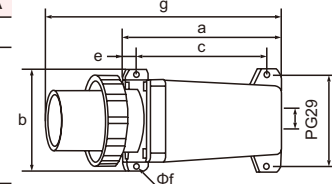

**FNP1-634
FNP1-644**

电流 Current(A):63A 125A
电压 Voltage(V):380-415V~
防护等级 Protection degree:IP67

Earth contact position		6h	
Normal current(A)		63A	125A
No.poles		3P+N+E	
Dimension(mm)	a	193	220
	b	122	140
	c	157	185
	d	109	130
	e	19	17
	f	6	8
	g	288	330
	h	127	140
Cable nominal cross-section area(mm ²)		6-16	16-50

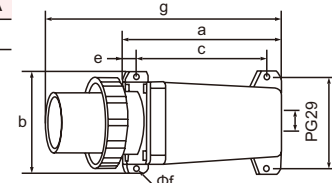

**FNP1-635
FNP1-645**

电流 Current(A):63A 125A
电压 Voltage(V):200-346V~
240-415V~
防护等级 Protection degree:IP67

Earth contact position		6h	
Normal current(A)		16A	32A
No.poles		2P+E	
Dimension(mm)	a	130	144
	b	82	82
	PG	21	21
Cable nominal cross-section area(mm ²)		1-2.5	2.5-6

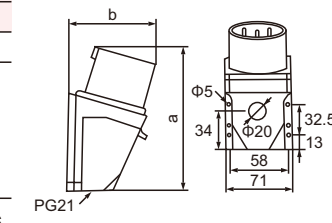

**FNP2-613
FNP2-623**

电流 Current(A):16A 32A
电压 Voltage(V):200-250V~
防护等级 Protection degree:IP44

Earth contact position		6h	
Normal current(A)		16A	32A
No.poles		3P+E	
Dimension(mm)	a	135	144
	b	82	82
	PG	21	21
Cable nominal cross-section area(mm ²)		1-2.5	2.5-6

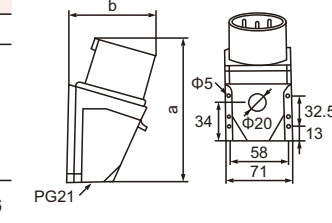

**FNP2-614
FNP2-624**

电流 Current(A):16A 32A
电压 Voltage(V):380-415V~
防护等级 Protection degree:IP44

Earth contact position		6h	
Normal current(A)		16A	32A
No.poles		3P+N+E	
Dimension(mm)	a	135	148
	b	82	82
	PG	21	21
Cable nominal cross-section area(mm ²)		1-2.5	2.5-6

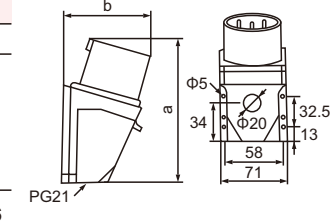

**FNP2-615
FNP2-625**

电流 Current(A):16A 32A
电压 Voltage(V):200-346V~
240-415V~
防护等级 Protection degree:IP44

电流 63A/125A 防水等级 IP67
FNP1代 经济型明装器具插座

电流 16A/32A 防水等级 IP44
FNP2代 螺旋快速安装型明装器具插座

电流 16A/32A 防水等级 IP44
FNP1 一代 经济型暗装器具插座



FNP1-513
FNP1-523
电流 Current(A):16A 32A
电压 Voltage(V):200-250V~
防护等级 Protection degree:IP44

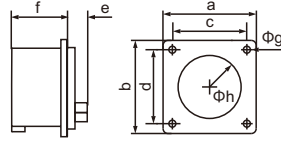

Earth contact position	6h	
Normal current(A)	16A	32A
No.poles	2P+E	
Dimension(mm)	a×b	70 70
	c×d	56 56
	e	25 30
	f	41 50
	g	5 5
	h	43 55
Cable nominal cross-section area(mm ²)	1-2.5	2.5-6

FNP1-514
FNP1-524
电流 Current(A):16A 32A
电压 Voltage(V):380-415V~
防护等级 Protection degree:IP44

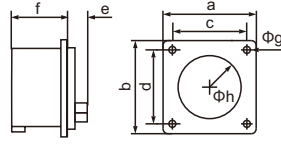

Earth contact position	6h	
Normal current(A)	16A	32A
No.poles	3P+E	
Dimension(mm)	a×b	70 70
	c×d	56 56
	e	25 30
	f	41 50
	g	5 5
	h	43 55
Cable nominal cross-section area(mm ²)	1-2.5	2.5-6

FNP1-515
FNP1-525
电流 Current(A):16A 32A
电压 Voltage(V):200-346V~
240-415V~
防护等级 Protection degree:IP44

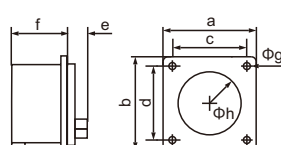

Earth contact position	6h	
Normal current(A)	16A	32A
No.poles	3P+N+E	
Dimension(mm)	a×b	70 70
	c×d	56 56
	e	26 30
	f	42 50
	g	5 5
	h	55 55
Cable nominal cross-section area(mm ²)	1-2.5	2.5-6

FNP1-533
FNP1-543
电流 Current(A):63A 125A
电压 Voltage(V):200-250V~
防护等级 Protection degree:IP67

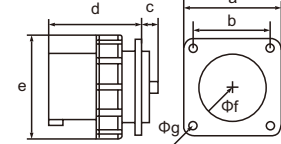

Earth contact position	6h	
Normal current(A)	63A	125A
No.poles	2P+E	
Dimension(mm)	a	100 120
	b	80 100
	c	20 22
	d	108 115
	e	109 124
	f	77 100
g	6.5 6.5	
Cable nominal cross-section area(mm ²)	6-16	16-50

FNP1-534
FNP1-544
电流 Current(A):63A 125A
电压 Voltage(V):380-415V~
防护等级 Protection degree:IP67

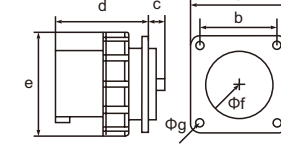

Earth contact position	6h	
Normal current(A)	63A	125A
No.poles	3P+E	
Dimension(mm)	a	100 120
	b	80 100
	c	20 22
	d	108 115
	e	109 124
	f	77 100
g	6.5 6.5	
Cable nominal cross-section area(mm ²)	6-16	16-50

FNP1-535
FNP1-545
电流 Current(A):63A 125A
电压 Voltage(V):200-346V~
240-415V~
防护等级 Protection degree:IP67

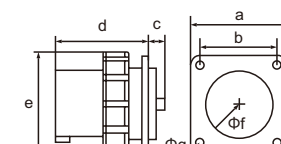

Earth contact position	6h	
Normal current(A)	63A	125A
No.poles	3P+E	
Dimension(mm)	a	100 120
	b	80 100
	c	20 22
	d	108 115
	e	109 124
	f	77 100
g	6.5 6.5	
Cable nominal cross-section area(mm ²)	6-16	16-50

电流 16A/32A 防水等级 IP44
FNP2 2代 螺旋快速安装型暗装器具插座



FNP2-513-4
FNP2-523-4
电流 Current(A):16A 32A
电压 Voltage(V):110-130V~
防护等级 Protection degree:IP44

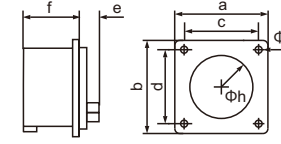

Earth contact position	4h	
Normal current(A)	16A	32A
No.poles	2P+E	
Dimension(mm)	a×b	75 75
	c×d	60 60
	e	25 30
	f	41 50
	g	5 5
	h	65 65
Cable nominal cross-section area(mm ²)	1-2.5	2.5-6

FNP2-513
FNP2-523
电流 Current(A):16A 32A
电压 Voltage(V):200-250V~
防护等级 Protection degree:IP44

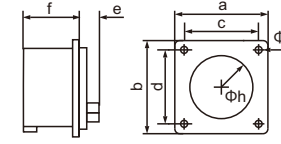

Earth contact position	6h	
Normal current(A)	16A	32A
No.poles	2P+E	
Dimension(mm)	a×b	75 75
	c×d	60 60
	e	25 30
	f	41 50
	g	5 5
	h	65 65
Cable nominal cross-section area(mm ²)	1-2.5	2.5-6

FNP2-514
FNP2-524
电流 Current(A):16A 32A
电压 Voltage(V):380-415V~
防护等级 Protection degree:IP44

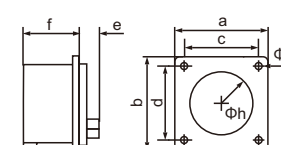

Earth contact position	6h	
Normal current(A)	16A	32A
No.poles	3P+E	
Dimension(mm)	a×b	75 75
	c×d	60 60
	e	25 30
	f	41 50
	g	5 5
	h	65 65
Cable nominal cross-section area(mm ²)	1-2.5	2.5-6

FNP2-515
FNP2-525
电流 Current(A):16A 32A
电压 Voltage(V):200-346V~
240-415V~
防护等级 Protection degree:IP44

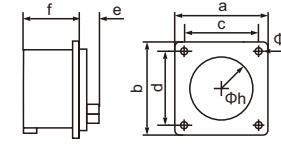

Earth contact position	6h	
Normal current(A)	16A	32A
No.poles	3P+N+E	
Dimension(mm)	a×b	75 75
	c×d	60 60
	e	26 30
	f	42 50
	g	5 5
	h	65 65
Cable nominal cross-section area(mm ²)	1-2.5	2.5-6

FNP2-513F
FNP2-523F
电流 Current(A):16A 32A
电压 Voltage(V):200-250V~
防护等级 Protection degree:IP67

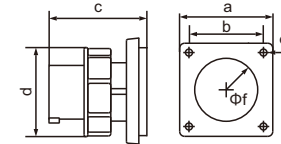

Earth contact position	6h	
Normal current(A)	16A	32A
No.poles	2P+E	
Dimension(mm)	a	76 76
	b	60 60
	c	63 74
	d	70 93
	e	65 65
	f	65 65
Cable nominal cross-section area(mm ²)	1-2.5	2.5-6

FNP2-514F
FNP2-524F
电流 Current(A):16A 32A
电压 Voltage(V):380-415V~
防护等级 Protection degree:IP67

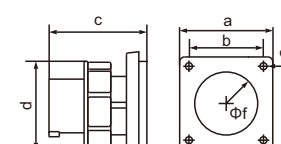

Earth contact position	6h	
Normal current(A)	16A	32A
No.poles	3P+E	
Dimension(mm)	a	76 76
	b	60 60
	c	63 74
	d	78 93
	e	65 65
	f	65 65
Cable nominal cross-section area(mm ²)	1-2.5	2.5-6

电流 63A/125A 防水等级 IP67
FNP1 一代 经济型暗装器具插座

电流 16A/32A 防水等级 IP67
FNP2 2代 螺旋快速安装型暗装器具插座

FNP2代 螺旋快速安装型暗装器具插座

欧式芯圆孔插头插座

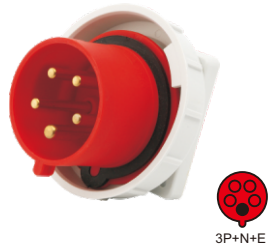

FNP2-515F
FNP2-525F
电流 Current(A):16A 32A
电压 Voltage(V):200-346V~
240-415V~
防护等级 Protection degree:IP67

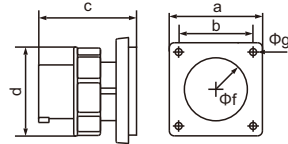

Earth contact position	6h	
Normal current(A)	16A	32A
No.poles	3P+N+E	
Dimension(mm)	a	76
	b	60
	c	63
	d	87
	f	65
Cable nominal cross-section area(mm ²)	1-2.5	2.5-6

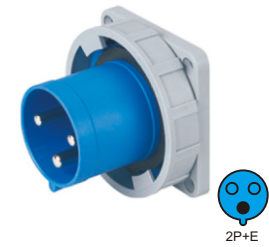

FNP2-533F
FNP2-543F
电流 Current(A):63A 125A
电压 Voltage(V):200-250V~
防护等级 Protection degree:IP67

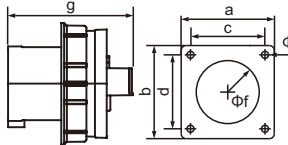

Earth contact position	6h	
Normal current(A)	63A	125A
No.poles	2P+E	
Dimension(mm)	a×b	105 120
	c×d	85 100
	f	85 100
	g	115 140
	Cable nominal cross-section area(mm ²)	6-16

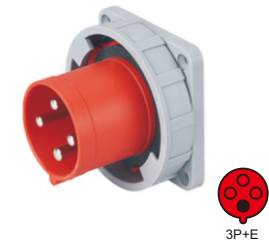

FNP2-534F
FNP2-544F
电流 Current(A):63A 125A
电压 Voltage(V):380-415V~
防护等级 Protection degree:IP67

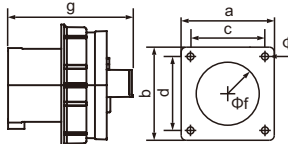

Earth contact position	6h	
Normal current(A)	63A	125A
No.poles	3P+E	
Dimension(mm)	a×b	105 120
	c×d	85 100
	f	85 100
	g	115 140
	Cable nominal cross-section area(mm ²)	6-16

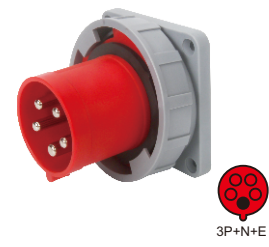

FNP2-535F
FNP2-545F
电流 Current(A):63A 125A
电压 Voltage(V):200-346V~
240-415V~
防护等级 Protection degree:IP67

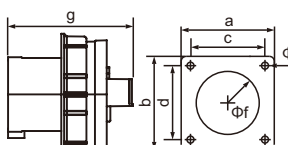

Earth contact position	6h	
Normal current(A)	63A	125A
No.poles	3P+N+E	
Dimension(mm)	a×b	105 120
	c×d	85 100
	f	85 100
	g	115 140
	Cable nominal cross-section area(mm ²)	6-16



FNP1-012
电流 Current(A):16A
电压 Voltage(V):220-250V~
防护等级 Protection degree:IP44

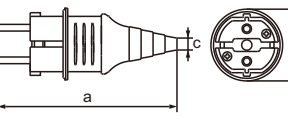

Normal current(A)	16A	
No.poles	2P+E	
Dimension(mm)	a	104
	b	142
	c	5
Cable nominal cross-section area(mm ²)	1-2.5	



FNP1-212
电流 Current(A):16A
电压 Voltage(V):220-250V~
防护等级 Protection degree:IP44

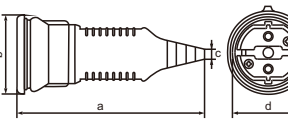

Normal current(A)	16A	
No.poles	2P+E	
Dimension(mm)	a	131
	b	53
	c	5
	d	46
Cable nominal cross-section area(mm ²)	1-2.5	

Normal current(A)	16A	
No.poles	2P+E	
Dimension(mm)	a	50.6
	b	65
	c	42
	d	26
	e	38.2
	f	38.2
	g	4.5
Cable nominal cross-section area(mm ²)	1-2.5	

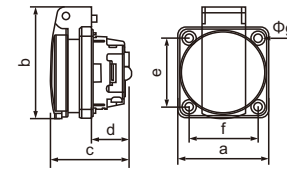

FNP1-112R
电流 Current(A):16A
电压 Voltage(V):220-240V
防护等级 Protection degree:IP44

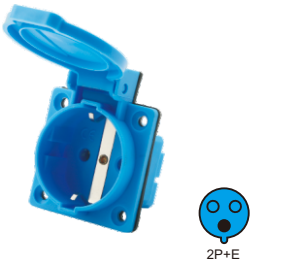

Normal current(A)	16A	
No.poles	2P+E	
Dimension(mm)	a	50.6
	b	65
	c	42
	d	26
	e	38.2
	f	38.2
	g	4.5
Cable nominal cross-section area(mm ²)	1-2.5	

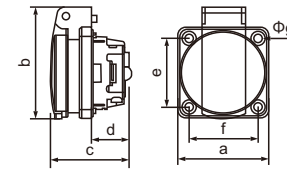

FNP1-112F
电流 Current(A):16A
电压 Voltage(V):220-240V
防护等级 Protection degree:IP44

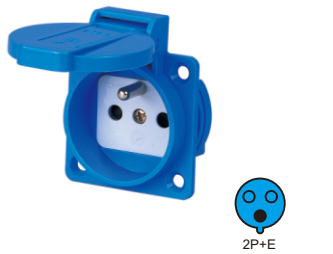

Normal current(A)	16A	
No.poles	2P+E	
Dimension(mm)	a	50.6
	b	65
	c	42
	d	26
	e	38.2
	f	38.2
	g	4.5
Cable nominal cross-section area(mm ²)	1-2.5	

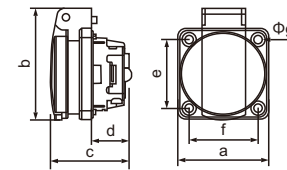

FNP1-112D
电流 Current(A):13A
电压 Voltage(V):220-240V
防护等级 Protection degree:IP44



Earth contact position	6h	
Normal current(A)	16A	32A
No.poles	2P+E	
Dimension(mm)	a	90
	b	180
	c	119
Cable nominal cross-section area(mm ²)	1-2.5	2.5-6

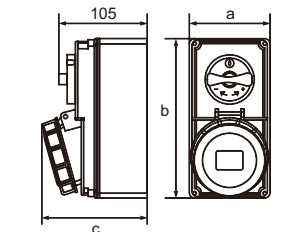

FNP7-113
FNP7-123
电流 Current(A):16A 32A
电压 Voltage(V):200-250V~
防护等级 Protection degree:IP67



Earth contact position	6h	
Normal current(A)	16A	32A
No.poles	3P+E	
Dimension(mm)	a	90
	b	180
	c	120
Cable nominal cross-section area(mm ²)	1-2.5	2.5-6

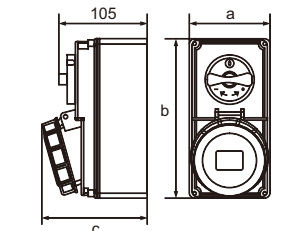

FNP7-114
FNP7-124
电流 Current(A):16A 32A
电压 Voltage(V):380-415V~
防护等级 Protection degree:IP67



Earth contact position	6h	
Normal current(A)	16A	32A
No.poles	3P+N+E	
Dimension(mm)	a	90
	b	180
	c	120
Cable nominal cross-section area(mm ²)	1-2.5	2.5-6

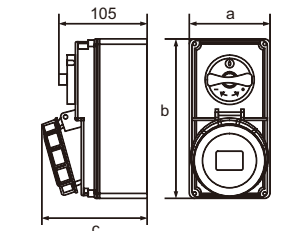

FNP7-115
FNP7-125
电流 Current(A):16A 32A
电压 Voltage(V):200-346V~
240-415V~
防护等级 Protection degree:IP67



机械连锁插座箱



**FNP7-Z313
FNP7-Z323**

电流 Current(A):16A 32A
电压 Voltage(V):200-250V~
防护等级 Protection degree:IP44

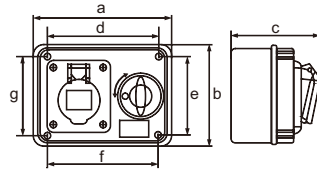

Earth contact position		6h	
Normal current(A)		16A	32A
No.poles		2P+E	
Dimension(mm)	a	168	168
	b	120	120
	c	108	108
	d	148	148
	e	100	100
	f	148	148
	g	100	100
Cable nominal cross-section area(mm ²)		1-2.5	2.5-6



**FNP7-Z314
FNP7-Z324**

电流 Current(A):16A 32A
电压 Voltage(V):380-415V~
防护等级 Protection degree:IP44

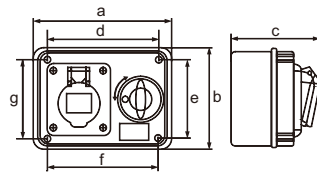

Earth contact position		6h	
Normal current(A)		16A	32A
No.poles		3P+E	
Dimension(mm)	a	168	168
	b	120	120
	c	108	108
	d	148	148
	e	100	100
	f	148	148
	g	100	100
Cable nominal cross-section area(mm ²)		1-2.5	2.5-6



**FNP7-Z315
FNP7-Z325**

电流 Current(A):16A 32A
电压 Voltage(V):200-346V~
240-415V~
防护等级 Protection degree:IP44

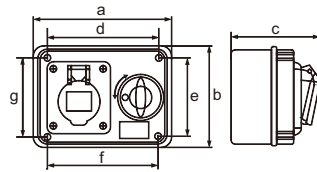

Earth contact position		6h	
Normal current(A)		16A	32A
No.poles		3P+N+E	
Dimension(mm)	a	168	168
	b	120	120
	c	108	108
	d	148	148
	e	100	100
	f	148	148
	g	100	100
Cable nominal cross-section area(mm ²)		1-2.5	2.5-6



**FNP6-1012
FNP6-1022**

输入 Input:1plug 16A/32A 220V~
输出 Output:2 sockcts 16A/32A 220V~
防护等级 Protection degree:IP44



**FNP6-S1013
FNP6-S1023**

输入 Input:1plug 16A/32A 220V~
输出 Output:2 sockcts 16A/32A 220V~
防护等级 Protection degree:IP44



**FNP6-1012-4
FNP6-1022-4**

输入 Input:1plug 16A/32A 110V~
输出 Output:2 sockcts 16A/32A 110V~
防护等级 Protection degree:IP44



**FNP6-10132
FNP6-10232**

输入 Input:1plug 16A/32A 220V~
输出 Output:2 sockcts 16A/32A 220V~
防护等级 Protection degree:IP67



**FNP6-1014-2
FNP6-1024-2**

输入 Input:1plug 16A/32A 380V~
输出 Output:2 sockcts 16A/32A 380V~
防护等级 Protection degree:IP44



**FNP6-10132-1
FNP6-10232-2**

输入 Input:1plug 16A/32A 220V~
输出 Output:2 sockcts 16A/32A 220V~
防护等级 Protection degree:IP67



**FNP6-1013-4
FNP6-1023-4**

输入 Input:1plug 16A/32A 110V~
输出 Output:2 sockcts 16A/32A 110V~
防护等级 Protection degree:IP44



**FNP6-S1014
FNP6-S1024**

输入 Input:1plug 16A/32A 380V~
输出 Output:2 sockcts 16A/32A 380V~
防护等级 Protection degree:IP44



**FNP6-1013
FNP6-1023**

输入 Input:1plug 16A/32A 220V~
输出 Output:2 sockcts 16A/32A 220V~
防护等级 Protection degree:IP44



**FNP6-10142
FNP6-10242**

输入 Input:1plug 16A/32A 380V~
输出 Output:2 sockcts 16A/32A 380V~
防护等级 Protection degree:IP67



**FNP6-1014
FNP6-1024**

输入 Input:1plug 16A/32A 380V~
输出 Output:2 sockcts 16A/32A 380V~
防护等级 Protection degree:IP44



FNP6-1152112R

电流 Current(A):16A 32A
电压 Voltage(V):200-346V~
240-415V~
防护等级 Protection degree:IP44



FNP6-613/3×413

输入 Input:1plug 16A/32A 220V~
输出 Output:3 sockcts 16A/32A 220V~
防护等级 Protection degree:IP44



FNP6-1605B

输入 Input:1plug 16A 415V~
输出 Output:1 sockcts 16A 220V~
2 sockcts 16A 415V~
防护等级 Protection degree:IP44



FNP6-1605A

输入 Input:1plug 16A 415V~
输出 Output:3 sockcts 10A 220V~
1 sockcts 16A 415V~
防护等级 Protection degree:IP44



FNP6-1605C

输入 Input:1plug 16A 415V~
输出 Output:3 sockcts 10A 220V~
1 sockcts 16A 415V~
防护等级 Protection degree:IP44



FNP6-615/3×415

输入 Input:1plug 16A 415V~
输出 Output:3 sockcts 16A 415V~
防护等级 Protection degree:IP44



FNP6-615/3×413

输入 Input:1plug 16A 415V~
输出 Output:3 sockcts 16A 220V~
防护等级 Protection degree:IP44

12位移动式防水插座箱
12 mobile waterproof socket box

执行标准: EN60439-4
Implementation of the standards: EN60439-4
防护等级: IEC60529 IP44/IP67
Protection class: IEC60529 IP44/IP67
颜色可选: 黄 / 黑
Colors: Yellow / Black

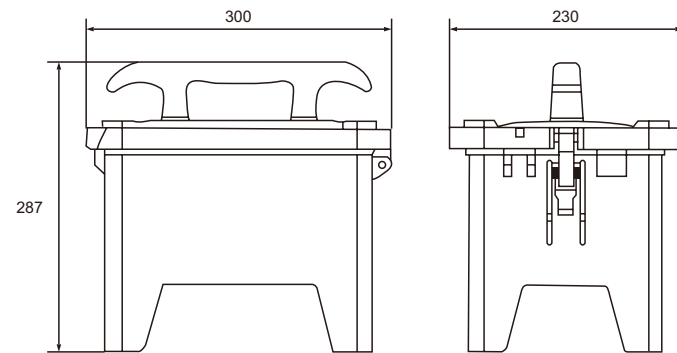

24位移动式防水插座箱
24 mobile waterproof socket box

执行标准: EN60439-4
Implementation of the standards: EN60439-4
防护等级: IEC60529 IP44/IP67
Protection class: IEC60529 IP44/IP67
颜色可选: 黄 / 黑
Colors: Yellow / Black



▲ FNP8-P202401

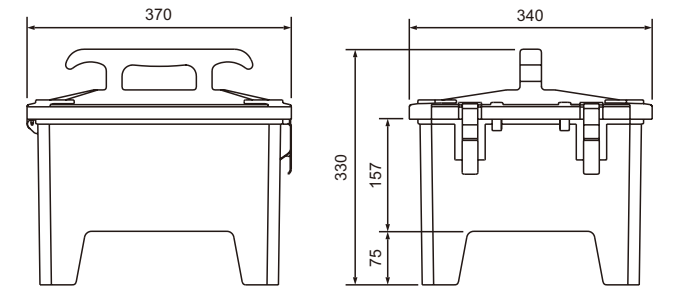

尺寸Dimension: 370×340×330
输入Input: 1 plug 63A 5P Ip67
输出Output: 1 Socket 63A 5P Ip67
4 Sockets 16A 5P Ip67
2 Sockets 32A 5P Ip67
保护Protection: 1 RCD 63A 4P 0.03A
1 MCB 63A 3P
2 MCB 32A 3P
4 MCB 16A 1P



▲ FNP8-P201201

尺寸Dimension: 300×287×230
输入Input: 3M H07RN Cable 5G2.5 with plug 16A 3P IP67
输出Output: 2 Sockets 16A 3P IP67
6 SCHUKO 16A
保护Protection: 1 MCB 16A 3P
3 MCB 16A 1P
1 RCD 4P 63A/0.03A



▲ FNP8-P201202

尺寸Dimension: 300×287×230
输入Input: 3M H07RN Cable 5G2.5 with plug 16A 3P IP44
输出Output: 2 Sockets 16A 3P IP44
6 SCHUKO 16A
保护Protection: 1 MCB 16A 3P
3 MCB 16A 1P
1 RCD 4P 63A/0.03A

36位移动式防水插座箱
36 mobile waterproof socket box

执行标准: EN60439-4
Implementation of the standards: EN60439-4
防护等级: IEC60529 IP44/IP67
Protection class: IEC60529 IP44/IP67
颜色可选: 黄 / 黑
Colors: Yellow / Black



▲ FNP8-P203601

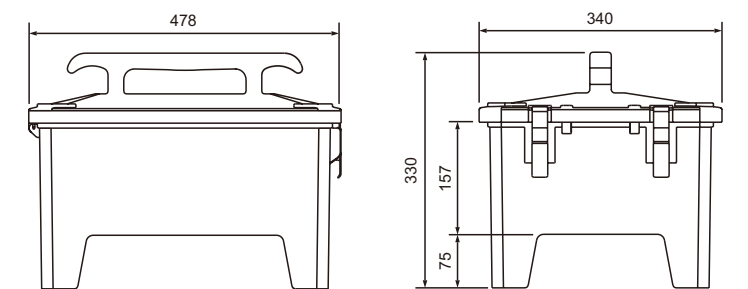

尺寸Dimension: 478×340×330
输入Input: 1 plug 63A 5P Ip67
输出Output: 7 Sockets 32A 5P Ip67
5 Sockets 16A 3P Ip67
保护Protection: 1 RCD 63A 4P 0.03A
7 MCB 32A 3P
5 MCB 16A 1P

便携式组合插座箱
Portable combined socket box

防水、防尘、耐腐蚀、高强度绝缘。
可根据用户需求随意开孔, 规格齐全, 安装方便。
Waterproof, dustproof, anticorrosion, high-strength insulation
Any opening is available according to the customers' demands, it is very complete in specification and convenient in installation.



▲ FNP8-P101

尺寸Dimension: 340×220×150
输入Input: 2M H07RN Cable 5G4 with plug 32A 5P
输出Output: 2 Sockets 16A 3P
2 Sockets 32A 5P
保护Protection: 2 MCB 1P 16A
2 MCB 3P 32A
1 RCD 4P 63A/0.03A



▲ FNP8-P102

尺寸Dimension: 300×400×160
输出Input: 2 Wall Switches
2 Sockets 16A 3P IP67
保护Protection: 4 MCB 1P 16A
1 MCB 2P 40A



▲ FNP8-P103

尺寸Dimension: 300×520×160
输出Input: 1 socket 3P 16A
1 socket 3P 32A
1 socket 4P 16A
1 socket 4P 32A
1 socket 5P 16A
1 socket 5P 32A
保护Protection: 1 MCB 1P 16A
1 MCB 1P 32A
2 MCB 3P 16A
2 MCB 3P 32A



▲ FNP8-P1101

执行标准: EN60439-4
Implementation of the standards: EN60439-4
防护等级: IEC60529 IP44/IP67
Protection class: IEC60529 IP44/IP67

尺寸Dimension: 500×680×200
输入Input: 1 plug 63A 5P
输出Output: 1 Socket 63A 5P
3 Sockets 32A 5P
3 Sockets 16A 5P
4 Sockets 16A 3P
4 Sockets 16A 2P
保护Protection: 1 RCD 63A 4P 0.03A
8 MCB 16A 1P
3 MCB 16A 3P
3 MCB 32A 3P
1 MCB 63A 3P

型号 Type	外型尺寸 Outline dimension(mm)			防护等级 protection class
	a	b	c	
FNP8-P1-01	220	340	150	IP65
FNP8-P1-02	300	400	160	IP65
FNP8-P1-03	300	520	160	IP65
FNP8-P1-04	270	460	160	IP65
FNP8-P1-05	360	540	180	IP65
FNP8-P1-06	230	330	160	IP65
FNP8-P1-07	280	280	160	IP65
FNP8-P1-08	360	360	160	IP65
FNP8-P1-09	600	800	220	IP65
FNP8-P1-10	500	680	200	IP65

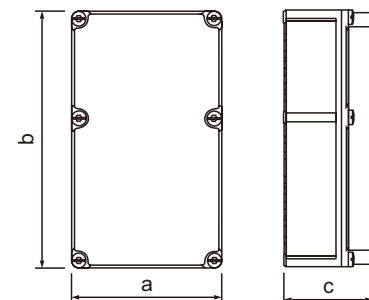
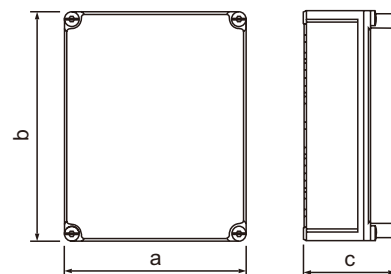

执行标准: EN60439-4
Implementation of the standards: EN60439-4
防护等级: IEC60529 IP44/IP67
Protection class: IEC60529 IP44/IP67

尺寸Dimension: 500×680×200
输入Input: 1 plug 63A 5P
输出Output: 2 Socket 32A 5P
8 Sockets 16A 2P
保护Protection: 1 RCD 63A 4P 0.03A
2 MCB 32A 3P
8 MCB 16A 1P



▲ FNP8-P10-01

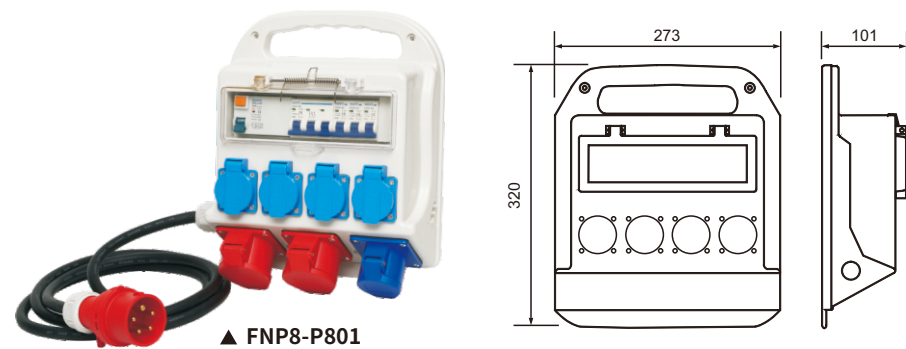

▲ FNP8-P801

技术参数 Technical parameters

尺寸Dimension: 273×320×101
输入Input: 2M H07RN Cable 5G4 with plug 32A 5P
输出Output: 4 Sockets 16A 3P
2 Sockets 32A 5P
1 Socket 16A 3P
保护Protection: 1 MCB 16A 3P
3 MCB 16A 1P
1 RCD 4P 63A/0.03A
防护等级Protection Degree: IP44

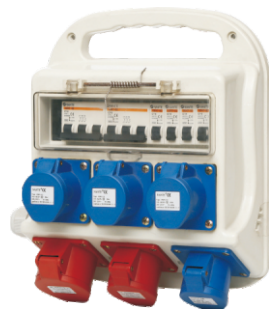

▲ FNP8-P804

技术参数 Technical parameters

尺寸Dimension: 273×320×101
输出Output: 4 Sockets 16A 3P
1 Socket 16A 4P
1 Socket 16A 5P
保护Protection: 2 MCB 16A 3P
4 MCB 16A 1P
防护等级Protection Degree: IP44



▲ FNP8-P805

技术参数 Technical parameters

尺寸Dimension: 273×320×101
输入Input: 1 Plug 16A 5P
输出Output: 4 Sockets 13A 3P
1 Socket 16A 5P
1 Socket 32A 5P
保护Protection: 1 MCB 16A 3P
4 MCB 13A 1P
1 RCD 4P 63A/0.03A
防护等级Protection Degree: IP44



▲ FNP8-P901

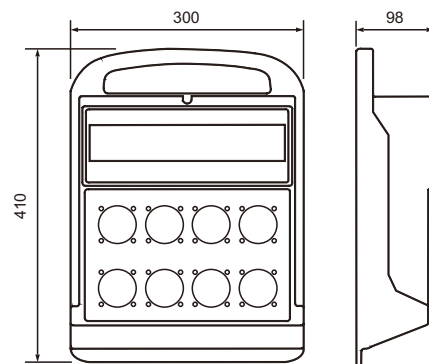

技术参数 Technical parameters

尺寸Dimension: 300×410×98
输入Input: 1 Plug 32A 5P
输出Output: 8 Sockets 16A 3P
1 Socket 16A 4P
1 Socket 32A 5P
保护Protection: 1 MCB 16A 3P
4 MCB 16A 1P
1 RCD 4P 63A/0.03A
防护等级Protection Degree: IP44



▲ FNP8-P301

技术参数 Technical parameters

尺寸Dimension: 260×170×140
输出Output: 1 Socket 16A 5P
2 Sockets 16A 3P
保护Protection: 1 MCB 16A 3P C type
2 MCB 16A 1P C type
防护等级Protection Degree: IP44



▲ FNP8-P302

技术参数 Technical parameters

尺寸Dimension: 260×170×140
输出Output: 2 Sockets 16A 5P
保护Protection: 2 MCB 16A 3P C type
防护等级Protection Degree: IP44

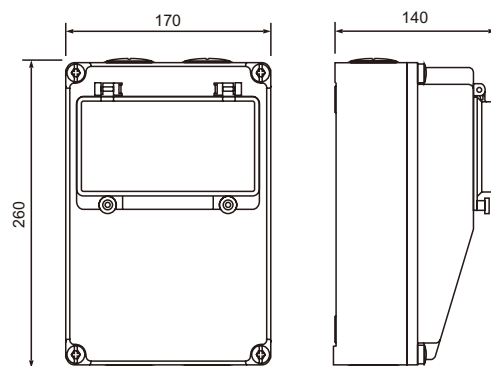

▲ FNP8-P601

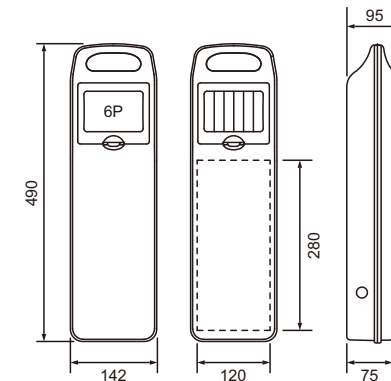

技术参数 Technical parameters

尺寸Dimension: 490×142×95
输入Input: 3M H07RN Cable 5G2.5 with plug 16A 3P 110V
输出Output: 3 Sockets 16A 3P 110V
保护Protection: 3 MCB 16A 1P
1 RCD 4P 63A/0.03A
防护等级Protection Degree: IP44



▲ FNP8-P701

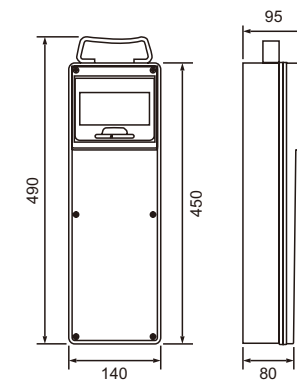

技术参数 Technical parameters

尺寸Dimension: 490×140×95
输入Input: 3M H07RN Cable 5G2.5 with plug 16A 3P
输出Output: 3 Sockets 16A 3P
保护Protection: 3 MCB 16A 1P
1 RCD 4P 63A/0.03A
防护等级Protection Degree: IP44

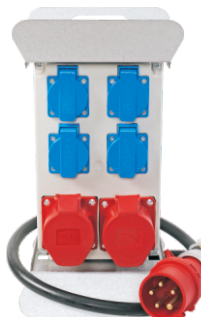

▲ FNP8-P401

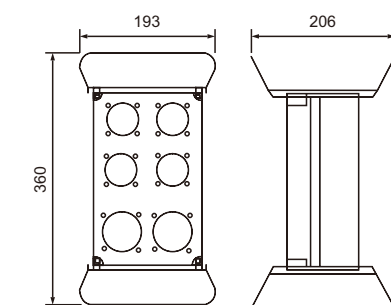

技术参数 Technical parameters

尺寸Dimension: 360×193×206
输入Input: 1M H07RN Cable 5G2.5 with plug 16A 5P
输出Output: 4 Sockets 16A 3P
2 Sockets 16A 5P
防护等级Protection Degree: IP44



▲ FNP8-P501

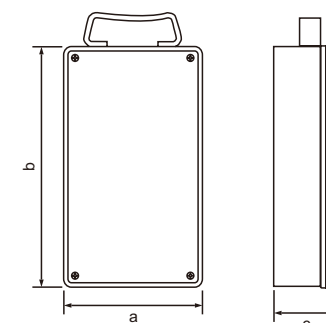

技术参数 Technical parameters

输出Output: 3 Sockets 16A 3P
防护等级Protection Degree: IP44

Box size:(mm)
58*64*35 100*100*75
80*110*70 125*125*75
80*130*70 150*200*100
80*180*70 150*250*100